

TM-9-2320-212-10

**M37
Series**

**OPERATOR'S
MANUAL**

DEPARTMENT OF THE ARMY TECHNICAL MANUAL
TRUCK, CARGO: 3/4-TON, 4x4, M37, M37B1
TRUCK, AMBULANCE: 4x4, M43, M43B1
TRUCK, MAINTENANCE: 4x4, M201, M201B1



TA 000616

HEADQUARTERS, DEPARTMENT OF THE ARMY 30 NOVEMBER 1973

Compliments of Militarytrucks.ca

SHE'S YOUR BABY NOW SOLDIER!

(ALL 8000 LBS.)

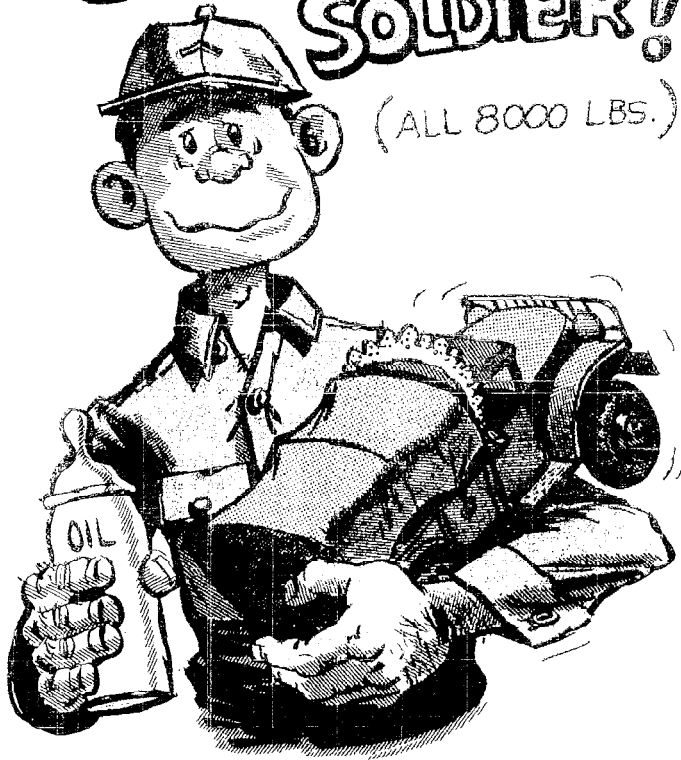

TA 000617

TABLE OF CONTENTS

	Para	Page
CHAPTER 1. INTRODUCTION		
Section I. GENERAL		
Purpose and Scope	1-1	1-1
Maintenance Forms and Records . .	1-2	1-1
Recommending Improvements . . .	1-3	1-1
II. DESCRIPTION AND DATA		
Description	1-4	1-2
Tabulated Data	1-5	1-3
Components of End Item	1-6	1-3
Expendable Consumable Maintenance Supplies and Materials	1-7	1-3
CHAPTER 2. OPERATING INSTRUCTIONS		
Section I. OPERATING PROCEDURES		
General	2-1	2-1
Preparation of Vehicle Before Operation	2-2	2-1
Operating Precautions	2-3	2-2
Before-Starting Operations	2-4	2-6
Starting the Engine	2-5	2-7
Driving the Vehicle	2-6	2-9
Stopping the Vehicle	2-7	2-12
Driving in Reverse	2-8	2-13
Parking the Vehicle	2-9	2-14
Use of the Transfer	2-10	2-15
Driving on Steep Grades	2-11	2-17
Operating Ambulance Truck	2-12	2-18
II. OPERATION OF AUXILIARY EQUIPMENT		
Top Operation (M37 and M201) . .	2-13	2-19
Winch and Power-Take-Off	2-14	2-24

TABLE OF CONTENTS – Continued

	Para	Page
CHAPTER 2. OPERATING INSTRUCTIONS – Continued		
Litter Racks (M43)	2-15	2-29
Ventilator Blowers (M43)	2-16	2-31
Personnel Heater (M43)	2-17	2-32
Ladder Rack Lock Control (M201)	2-18	2-33
Pole Rack Lock Control (M201)	2-19	2-33
Water Cask Fasteners (M201)	2-20	2-33
PR Reel (M201)	2-21	2-34
Spare Wheel Stowage	2-22	2-35
Fire Extinguisher	2-23	2-36
III. OPERATION UNDER UNUSUAL CONDITIONS		
General	2-24	2-37
Extreme-Cold Weather Conditions	2-25	2-38
Extreme-Cold Weather Operations	2-26	2-42
Extreme-Hot Weather Operations	2-27	2-52
Operation on Unusual Terrain	2-28	2-54
Fording Operations	2-29	2-67
Towing the Vehicle	2-30	2-71
Field Expedients	2-31	2-77

TABLE OF CONTENTS – Continued

	Para	Page
CHAPTER 3. MAINTENANCE INSTRUCTIONS		
Section I. LUBRICATION		
Lubrication Instructions	3-1	3-1
Service Intervals	3-2	3-1
II. PREVENTIVE MAINTENANCE CHECKS AND SERVICES		
General	3-3	3-4
Procedures	3-4	3-5
Cleaning Instructions	3-5	3-7
Cleaning Precautions	3-6	3-8
Preventive Maintenance	3-7	3-8
III. TROUBLESHOOTING		
General	3-8	3-20
Procedures	3-9	3-20
IV. MAINTENANCE PROCEDURES		
General	3-10	3-29
Wheel and Tire Replacement	3-11	3-29
Draining and Filling Cooling System	3-12	3-30
Checking Electrolyte in Batteries	3-13	3-32
Checking and Filling Carburetor Air Cleaner	3-14	3-33
Checking Engine Oil Level	3-15	3-35
Checking and Filling Gear Cases	3-16	3-36
APPENDIX A. REFERENCES		A-1
APPENDIX B. BASIC ISSUE ITEMS LIST (BIIL)		B-0

Warning Notes!

WARNING: Do not operate heater or engine in an enclosed area unless it is adequately ventilated. Exhaust fumes contain carbon monoxide, a colorless, odorless, poisonous gas. Permanent brain damage or death can result from prolonged exposure.

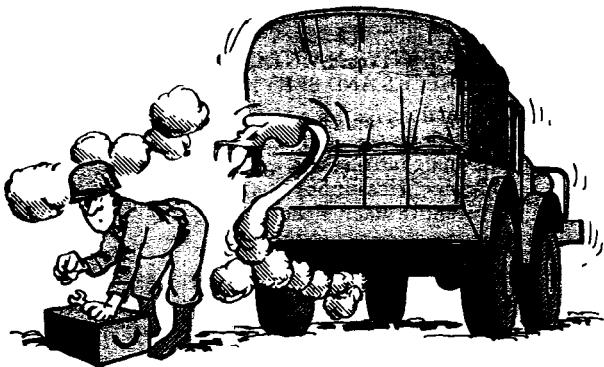

WARNING: Never leave the hood in the open position without securing it with the hood holder. A gust of wind or sudden jar may cause an unsupported hood to fall, resulting in serious or fatal injury to personnel.

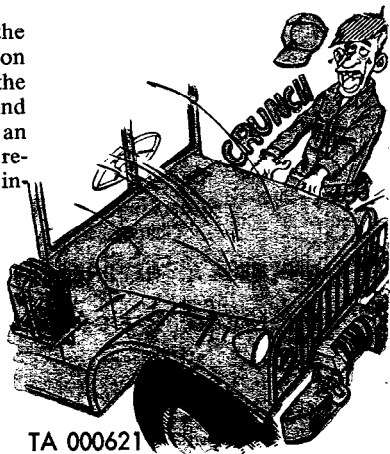

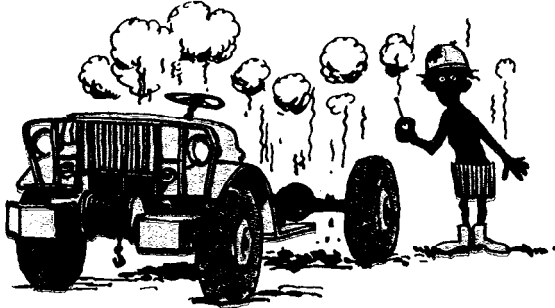

WARNING: Do not use an open flame type light to check fuel tank or tank filler neck strainer. When filling fuel tank, always hold pump hose nozzle firmly against strainer tube to prevent static sparks.

WARNING: Exercise extreme care when opening or removing the radiator cap, especially when coolant gage reads above 180°F. Do not fill radiator when vehicle is overheated.



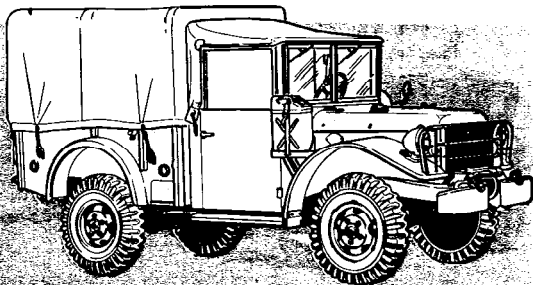

TRUCK, CARGO, 3/4-TON, M37 and M37B1
(2320-835-8323), (2320-542-4632)

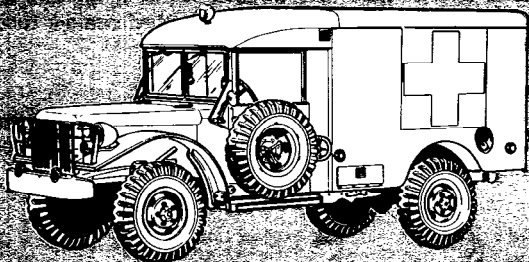

TRUCK, AMBULANCE, 3/4-TON, M43 and M43B1
(2310-835-8516), (2310-542-4634)

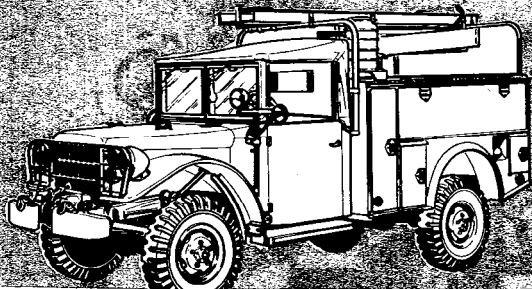

TRUCK, MAINTENANCE, 3/4-TON, M201 and M201B1
(2320-392-3703), (2320-630-6801)

CHAPTER 1

INTRODUCTION

Section I - GENERAL

1-1. Purpose and Scope.

This manual is for your use in operating and maintaining all of the 3/4 ton, 4 x 4 M37 series vehicles. This series vehicle includes the M37 and M37B1 3/4 ton Cargo Truck, M43 and M43B1 3/4 ton Ambulance Truck, and the M201 and M201B1 3/4 ton Telephone Maintenance Truck. It also provides the operating and maintenance instructions for special purpose equipment supplied with these vehicles.

1-2. Maintenance Forms and Records.

Maintenance forms and records that you are required to use are explained in TM 38-750.

1-3. Recommending Improvements.

You can improve this manual by recommending improvements using DA Form 2028 (Recommended Changes to Publications), or a letter, and mail direct to the Commander, U.S. Army Tank-Automotive Command, Attn., AMSTA-MAPT, Warren, Michigan 48090. A reply will be furnished direct to you.

Section II - DESCRIPTION AND DATA

1-4. Description.

a. The 3/4 ton, 4 x 4 Cargo Truck, Models M37 and M37B1, Ambulance Truck M43 and M43B1, and Telephone Maintenance Truck M201 and M201B1, are designed for use over all types of roads as well as cross-country terrain and in all weather conditions. The vehicles have four driving wheels. Front wheel drive may be engaged as road conditions and terrain require. The four speed transmission and dual range transfer unit adapt to a wide variety of driving situations. The vehicles are powered by a six cylinder, in-line, liquid cooled, gasoline engine. Vehicles have four-wheel hydraulic service brakes and a mechanical hand brake. Many are equipped with a front mounted winch, and all, except the Ambulance M43 and M43B1, are provided with a rear towing pintle. The hinged type spare wheel carrier (except M201 and M201B1) mounted on the cab left door can be unlocked from either the inside or outside, providing full use of the door.

b. The M37 or M37B1, 3/4 ton, 4 x 4 Cargo Truck is a general purpose personnel or cargo carrier. The open-type steel body is separate from the soft top cab and is furnished with folding troop seats. A roof tarpaulin, supported by bows, covers the cargo compartment. Canvas front and rear end curtains are provided with windows.

c. The M43 or M43B1, 3/4 ton, 4 x 4 Ambulance Truck is designed to carry six ambulatory or four litter patients. The panel-type closed steel body is longer and higher and consists of the driver's compartment and the patient's compartment with a connecting partition door. A spotlight is mounted on the roof of the cab.

d. The M201 or M201B1, 3/4 ton, 4 x 4 Telephone Maintenance Truck is designed for telephone installation, light maintenance and cable splicing service. The all steel body is separate from the soft top cab and incorporates compartments for stowage of tools and supplies. The spare wheel is located in

the right side front compartment of the body. A spotlight is mounted on a support at the left front fender.

e. If you need a detailed description of any component of the M37 series vehicles, ask your supervisor to see TM 9-2320-212-20.

1-5. Tabulated Data. (Page 1-4)

The tabulated data you will need for proper operation of the M37 series vehicles are contained in the table on Tabulated Data.

1-6. Components of End Item. (Page 1-6)

These items are listed in Table 1-1 and are installed in the vehicle at time of manufacture or rebuild. They are securely fastened, permanently attached, or placed behind a cover.

1-7. Expendable Consumable Maintenance
Supplies and Materials. (Page 1-7)

Refer to Table 1-2 for supplies and materials required for maintenance support of the equipment covered herein. These items are authorized to be requisitioned by SB700-50.



TABULATED DATA

a. General Data.

Capacities:

Cooling System	17 qt
Crankcase (refill)	5 qt
(when replacing oil filter element, add 1 extra qt)	
Differential (each):	
Fill	3 qt
Refill	2½ qt
Fuel tank	24 gal
Tires-mud and snow tread	9.00 x 16, 8 ply
Highway, cross-country: pressure	45 lb
Mud, snow, or sand: pressure	15 lb
Transfer	5 pt
Transmission:	
With power-take-off	
(through engine No. T245-3955)	10½ pt
(after engine No. T245-3955)	7 pt
Without power-take-off	
(through engine No. T245-3955)	9 pt
(after engine No. T245-3955)	6 pt
Winch clutch housing	1 qt
Winch worm housing	1 qt

Dimensions:

Height:

Cargo truck M37, M37B1	7 ft 2½ in.
Ambulance truck M43, M43B1	7 ft 9½ in.
Telephone maintenance truck	
M201, M201B1	7 ft 9½ in.

Length:

Cargo truck M37, M37B1 - w/o winch ..	15 ft 4¾ in.
Cargo truck M37, M37B1 - w/winch ..	15 ft 9-3/8 in.
Ambulance truck M43, M43B1	16 ft 6¾ in.
Telephone maintenance truck	
M201, M201B1	16 ft 6¾ in.

Width (all models)

	6 ft 1½ in.
--	-------------

Ground clearance

	10¾ in.
--	---------

Loading height (fully loaded):

Cargo truck	29¾ in.
Ambulance truck	30¾ in.
Maintenance truck	30½ in.

Pintle height (all models except M43)	
Empty	25-1/8 in.
Loaded	21-7/8 in.
Weight (net):	
Cargo truck M37, M37B1 (w/o winch)	5,687 lb
Cargo truck M37, M37B1 (w/winch)	5,917 lb
Ambulance truck M43, M43B1	7,150 lb
Telephone maintenance truck M201, M201B1	6,950 lb

b. Performance.

Allowable speed:

Transfer:	<u>1st</u>	<u>2d</u>	<u>3d</u>	<u>4th</u>	<u>Reverse</u>
High range	9	18	33	55	7-mph
Low range	4	9	17	28	4-mph

Cruising range (loaded) 225 miles

Fording depth (max.):

W/O fording kit	42 in.
W/fording kit	84 in.

Payload (all models except ambulance truck M43, M43B1):

Cross-country	1,500 lb
Highway	2,000 lb

Payload (ambulance truck M43, M43B1)

	1,400 lb
--	----------

Recommended towed load (max.):

Cross-country	4,000 lb
Highway	6,000 lb

Turning circle (dia.) right or left (min.) 50 ft

Winch capacity 7,500 lb



**Table 1-1. List of Component Items
(Installed Items)**

Federal Stock Number	Description	Unit of Meas.	Qty Auth.
2590-473-6331	Bracket; drum inflammable liquid w/strap (M37, M37B1, M56, M56B1, B56C, M201, M201B1) (installed on right front fender) (M43 and M43B1) (installed on right front fender and left rear door).	ea	1
4910-357-5494	Bracket, tool pioneer equipment set 41-B-1925 (M37 and M37B1) (installed on tailgate).	ea	1
4210-555-8837	Extinguisher, fire, w/ bracket, hand (M43, M43B1) 1059-6569-1.	ea	1
4010-297-1815	Cable: Assembly winch w/clevis and chain, composed of: 1 - chain, winch cable, ½ inch link, 4 foot long w/hook (M37, M37B1, M43, M201, M201B1) (installed on winch drum) 7717031 (19207).	ea	1

**Table 1-2. Expendable, Consumable Maintenance
Supplies and Material**

Federal Stock Number	Description	Unit of Meas.	Qty Auth.
5140-772-4142	Bag, Tool satchel: (empty) 20- $\frac{1}{4}$ x 18- $\frac{1}{4}$ (in tool compartment R or L front side of body exterior).	ea	1
7240-222-3088	Can, Gasoline, Military: 5-gallon (in bracket on right front fender) (M37, M37B1, M53B1, M56, M56B1, M56C, M201, M201B1).	ea	1
4010-473-6166	Chain, utility: 5/8- inch link x 16 feet long, w/hook, w/2/2 rear shape coupling end links (8-C-4355) (M201, M201B1) (in tool com- partment, R or L front side of body exterior).	ea	1
5120-293-3336	Shovel, Hand: General purpose, round point open back (M37, M37B1) (in bracket on tailgate).	ea	1

**Table 1-2. Expendable, Consumable Maintenance
Supplies and Material - Continued**

Federal Stock Number	Description	Unit of Meas.	Qty Auth.
7240-177-6154	Spout, can: flex nozzle, 2-½ inch diameter, 15-inch long (42-T-13600) (M37, M37B1, M53B1, M56, M56B1, M56C, M201, M201B1) (in tool compartment, R or L front side of body exterior) (M43, M43B1).	ea	1
6850-243-1992	Anti-freeze ethylene-glycol, 1-gal. can.	gal	V
6850-224-8730	Anti-freeze ethylene-glycol, 5-gal. can.	gal	V
6850-598-7328	Engine cooling system cleaning compound.	can	V
6850-926-2275	Cleaning compound, windshield washer, 1-pt can.	can	V
9150-190-0905	GAA, grease Lubr. Automotive and artillery, 5-lb can.	can	V
9150-190-0907	GAA, grease Lubr. Oil Preservative, 1-pt can.	can	V

**Table 1-2. Expendable, Consumable Maintenance
Supplies and Material - Continued**

Federal Stock Number	Description	Unit of Meas.	Qty Auth.
9150-186-6681	Lubricating Oil (OE 30 above $+32^{\circ}$ F).	qt	V
9150-189-6727	Lubricating Oil (OE 10 $+40^{\circ}$ F to -10° F).	qt	V
9150-242-7603	Lubricating Oil (OES 0° F to -65° F).	qt	V
9150-231-9071	Oil, Hydraulic, HB- nonpetroleum base, automotive.	gal	V
9150-252-6375	Oil, Hydraulic, HB- nonpetroleum base; automotive, arctic.	gal	V

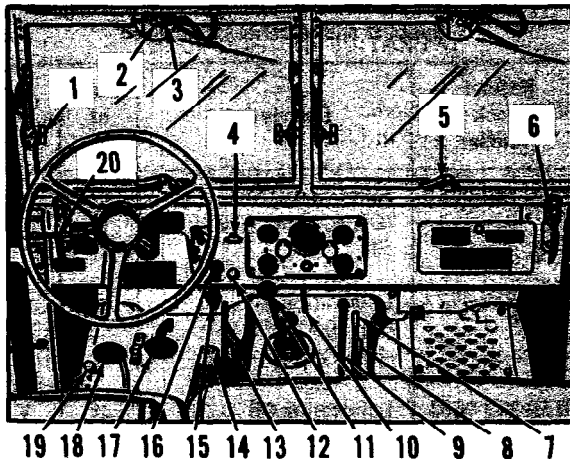

KEY:

- | | |
|--|-----------------------------------|
| 1. Windshield adjusting arm | 10. Cowl ventilator handle |
| 2. Windshield wiper handle | 11. Transmission gear shift lever |
| 3. Windshield wiper control knob | 12. Choke control |
| 4. Throttle control | 13. Power-take-off shift lever |
| 5. Windshield locking handle | 14. Accelerator pedal |
| 6. Windshield support frame clamp handle | 15. Starter pedal |
| 7. Transfer shift control lever (front) | 16. Ignition switch |
| 8. Transfer de-clutch control lever (rear) | 17. Brake pedal |
| 9. Handbrake lever | 18. Clutch pedal |
| | 19. Dimmer switch |
| | 20. Turn signal switch |

CHAPTER 2

OPERATING INSTRUCTIONS

WARNING: If equipment fails to operate, refer to troubleshooting procedures in Chapter 3.

Section I - OPERATING PROCEDURES

2-1. General.

This chapter describes, locates, and illustrates the controls, instruments, and equipment provided for proper operation of the M37 series vehicles. You should familiarize yourself with handling characteristics and precautionary measures necessary for safe operation of these vehicles.

2-2. Preparation of Vehicle Before Operation.

a. Before-Operation Instructions. Services to be performed by operator are explained in paragraph 3-3. Services to be performed by organizational maintenance personnel are designated in TM 9-2320-212-20.

b. Break-in Service.

(1) Perform all before-operation checks and inspections as indicated in Preventive Maintenance Checks and Services Table, Chapter 3.

(2) The following break-in speeds and precautions should be observed during the first 500 miles of operation.

(a) Do not exceed a speed of 28 miles per hour during the first 500 miles.

(b) After the first 500 miles, speeds may be increased slightly for brief periods until 2000 miles, have been completed.

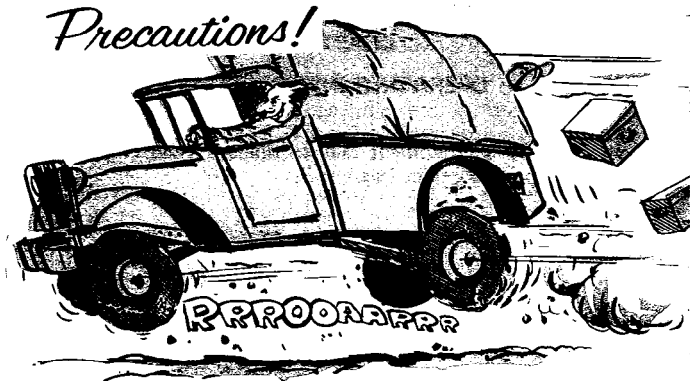

PRECAUTIONS

- (c) Do not drive at sustained high speed during the first 2000 miles of operation.
- (d) Do not skip speeds when shifting gears, up or down.
- (e) Accelerate the engine slowly and gradually.
- (f) Do not load the engine or power train to capacity.
- (g) Avoid overheating engine.

2-3. Operating Precautions.

a. The speeds indicated on the instruction plates of the dash panels are guides only to the mechanical capacity of the vehicle in each gear ratio. Data plate speeds do not imply or suggest permission to drive beyond limits of safety, which are dependent on road conditions, weather, visibility, loading, and your skill as an operator.

b. Always start out in first gear, regardless of terrain and wheel drive.

More Precautions!

c. Always bring vehicle to a complete stop before shifting into first or reverse gear.

d. Do not shift from 2-wheel drive into 4-wheel drive while moving. Stop, drop to idle . . . then make the shift.

e. Avoid skipping gears when shifting.

f. Never partially engage (ride) clutch.

g. Avoid racing the engine, especially when not under load.

h. If stuck or under heavy load, never race your engine and slip the clutch to gain more power – downshift. Damage will result to clutch, pressure plate and flywheel.

i. When vehicle is stuck, do not rock vehicle by shifting from first gear to reverse gear while throttle is partly open, (Page 2-49).

j. Never shift to front wheel drive while rear wheels are spinning.

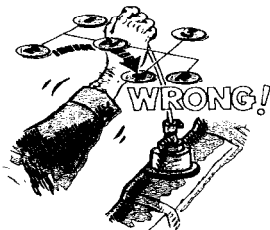

More Precautions!

k. Before going down a hill, slow down, get into the right gear for the slope, keep within the speed shown on the data plate, and avoid using or riding the clutch pedal while going down.

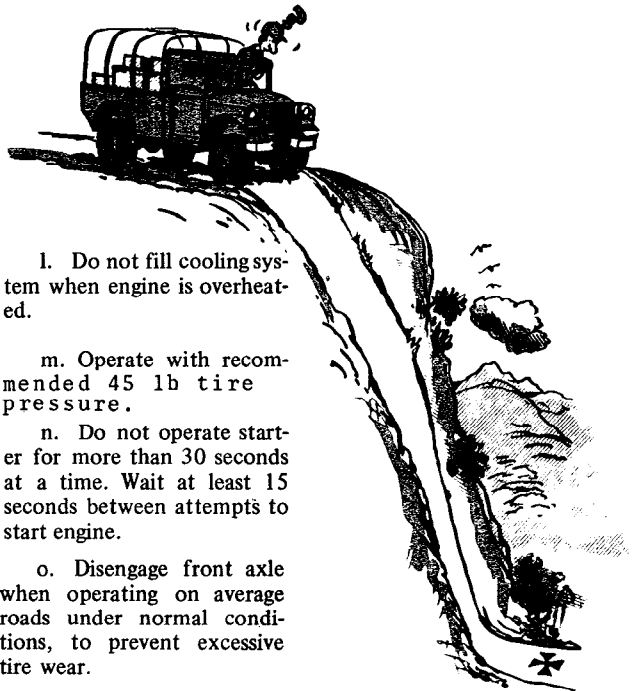

l. Do not fill cooling system when engine is overheated.

m. Operate with recommended 45 lb tire pressure.

n. Do not operate starter for more than 30 seconds at a time. Wait at least 15 seconds between attempts to start engine.

o. Disengage front axle when operating on average roads under normal conditions, to prevent excessive tire wear.

p. Be careful when using vehicle operating controls. Do not suddenly or forcefully engage operating controls.

More Precautions!

q. When applying the brakes, avoid severe application of the brake pedal.

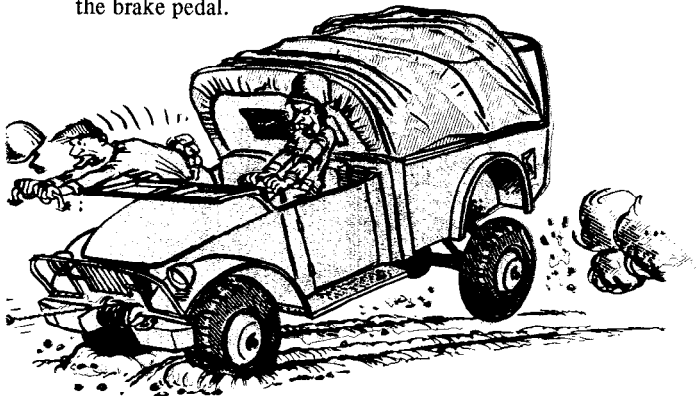

r. Excessive clutch slippage and failures are often caused by engine and transmission lubricants that become trapped in the flywheel housing and cover the clutch components. During normal operating conditions, remove the flywheel housing drain plug and store in the glove compartment.

s. The flywheel housing drain plug must be installed before the vehicle undergoes fording operations. It must also be installed before any other operations where extremely muddy terrain might be encountered.

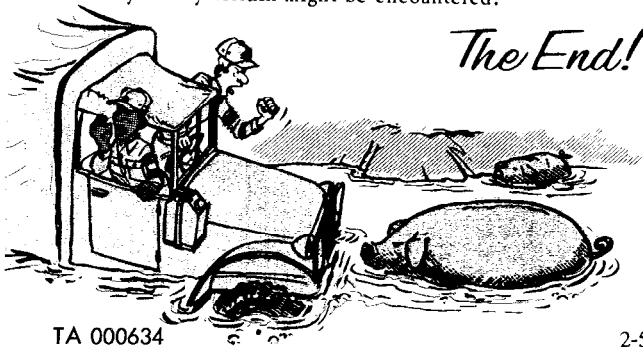

2-4. Before-Starting Operations.

Before starting engine, perform applicable before-operation inspections and services outlined in the Preventive Maintenance Checks and Services Table, Chapter 3.

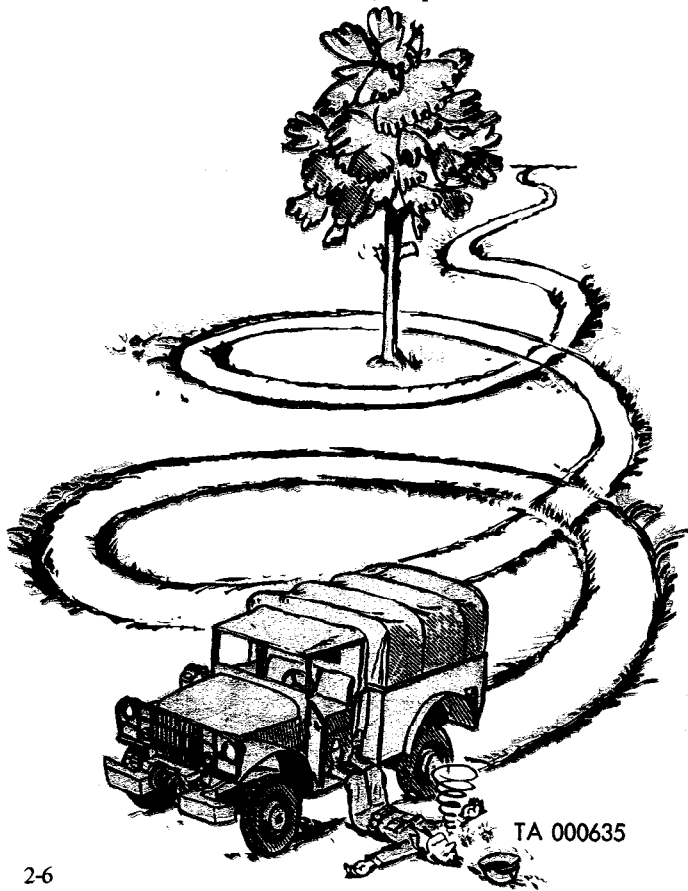

TA 000635

2-5. Starting the Engine. (Page 2-0).

- a. Adjust seat for most comfortable and effective position.
- b. Pull back on handbrake lever (9).
- c. Place transmission shift lever (11) in neutral position.

CAUTION: Make certain power-take-off shift lever (on vehicles so equipped) is locked in neutral position

- d. Pull out throttle control (4) about one-third of the travel distance.

- e. If the engine is cold, pull out the choke control (12) all the way (if engine is warm, do not use choke).

- f. Turn ignition switch (16) to ON position.

- g. Push in the clutch pedal (18) and depress starter (15). Release starter pedal when engine starts.

Note. Do not operate starter continuously for more than 30 seconds. If engine fails to start within 30 seconds, wait at least 15 seconds before trying again. If engine fails to start after a reasonable time, investigate (See Chapter 3, Section III, "Troubleshooting ") and correct cause.

- h. After engine has started, release clutch pedal, push throttle control part way in to reduce engine speed, and push choke control in until engine runs smoothly. (On vehicles equipped with locking throttle, turn the handle one-quarter turn counterclockwise, push in and turn one-quarter turn clockwise.)

i. Check oil pressure gage (4). Oil pressure should be 10 psi at low idle with higher pressure indicated as engine idle is increased.

CAUTION: If no pressure is indicated within 10 seconds after engine starts, stop the engine and investigate (See Chapter 3, Section III, "Troubleshooting") and correct cause.

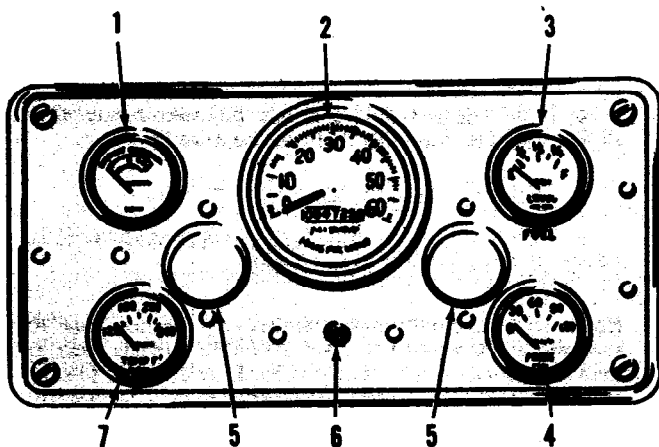

KEY:

- | | |
|---|---------------------------|
| 1. Battery generator indicator or ammeter | 4. Oil pressure gage |
| 2. Speedometer-odometer | 5. Instrument panel light |
| 3. Fuel gage | 6. High-beam indicator |
| | 7. Water temperature gage |

j. Run the engine at idle speed or slightly faster, until water temperature gage (7) indicates a rise in temperature before operating vehicle. Avoid high engine speeds during warm-up period. Check oil-pressure gage (4), water temperature gage (7), and battery generator indicator (1) for proper functioning. Battery generator indicator should read in green area.

k. Push choke control all the way in as soon as engine will operate without stalling.

2-6. Driving the Vehicle.

a. Set light switch for stop light operation (daytime) or designated lighting (night time).

Note. Stop light and turn signal light will operate only when light switch is in "stop light" or "service drive" position.

b. Push in the clutch pedal.

c. Place transmission shift lever in first gear. Refer to shift pattern on dash panel plate, (page 2-11).

d. Place the transfer shift control lever in desired range and the transfer declutch lever in desired drive position. Refer to shift pattern on dash panel plate and paragraph 2-10, below.

e. Release handbrake lever.

f. Depress the accelerator pedal and simultaneously release the clutch pedal with a steady, gradual motion to prevent sudden engagement. Accelerate gradually.

g. As vehicle speed increases, shift progressively through second and third gears to fourth gear using clutch and decreasing engine speed between each gear.

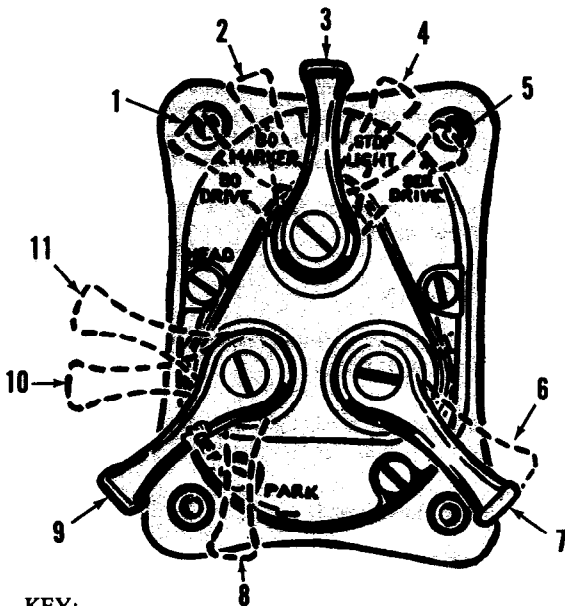

KEY:

- | | |
|--|---|
| 1. Upper lever in blackout drive position | 7. Lower right lever in locked position |
| 2. Upper lever in blackout marker position | 8. Lower left lever in park position |
| 3. Upper lever in off position | 9. Lower left lever in off position |
| 4. Upper lever in stoplight position | 10. Lower left lever in dim panel light position |
| 5. Upper lever in service drive position | 11. Lower left lever in bright panel light position |
| 6. Lower right lever in unlocked position | |

CAUTION: Avoid “riding” the clutch pedal, as this practice causes unnecessary wear of the clutch parts.

h. The transfer may be operated in high range with front axle engaged or disengaged (para. 2-10). When transfer is in low range, front axle is also engaged, preventing excessive strain on rear axle.

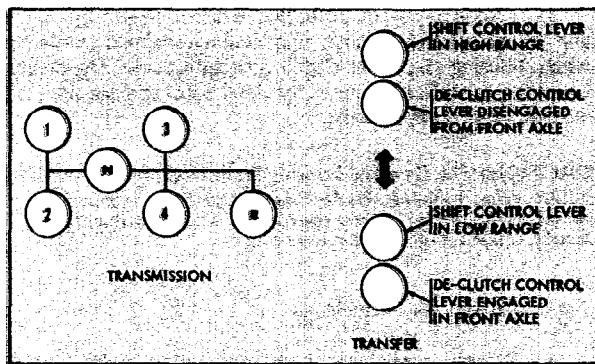

CAUTION: Front axle should be engaged only in off-the-road operation, on slippery roads, steep grades, or during hard pulling. Disengage front axle when operating on average roads under normal conditions, to prevent excessive tire wear.

i. For operation on a smooth level highway, use high range and be sure that the front axle is disengaged.

CAUTION: Do not attempt to shift either of the transfer control levers with the vehicle in motion, as serious damage to the transfer gears or other internal parts will result.

j. The transmission and transfer gearshift instruction plate on the dash panel shows maximum permissible road speeds in various gears. Do not exceed these speeds unless tactical conditions demand it.

CAUTION: Avoid excessive operation in the lower gears, as it will result in high engine speed.

k. Clutch slippage and failure is often caused by engine and transmission lubricants that become trapped in the flywheel housing and cover clutch components. During normal operating conditions, remove flywheel housing drain plug and store in glove compartment.

CAUTION: The flywheel housing drain plug must be installed before vehicle undergoes fording operations. It must be installed before any other operations where extremely muddy terrain might be encountered.

2-7 Stopping the Vehicle.

a. Release accelerator pedal and apply brakes. Apply brakes slowly to avoid skidding tires.

b. As the vehicle slows to a stop, depress clutch pedal and shift into neutral. Apply parking brake by pulling back on lever before releasing foot brake pedal.

c. Allow the engine to run a few minutes at idling speed, then turn ignition switch to OFF position.

CAUTION: When applying brakes, avoid severe application of brake pedal. Allow the engine to assist in slowing your vehicle.

2-8. Driving in Reverse.

- a. Bring vehicle to complete stop.
- b. Allow engine to return to idle speed. Push in clutch pedal and shift into reverse gear. Refer to shift pattern on dash panel.
- c. Release clutch pedal slowly.

CAUTION: Limit reverse speed to 7 mph. If in low range, limit reverse speed to 4 mph.

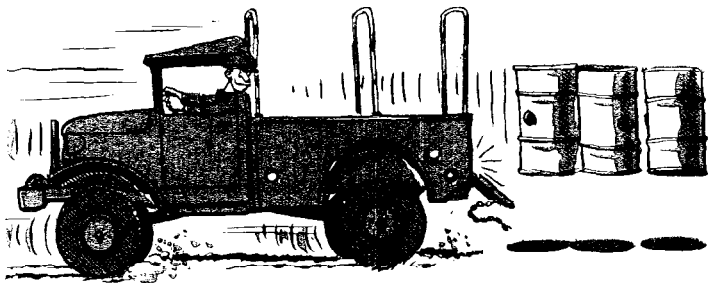

2-9. Parking the Vehicle.

- a. Put all switches in OFF position unless tactical situation requires otherwise.
- b. Apply parking brake. Chock wheels if on very steep grade.

CAUTION: When operating vehicles with towed load, always chock wheels when parking.

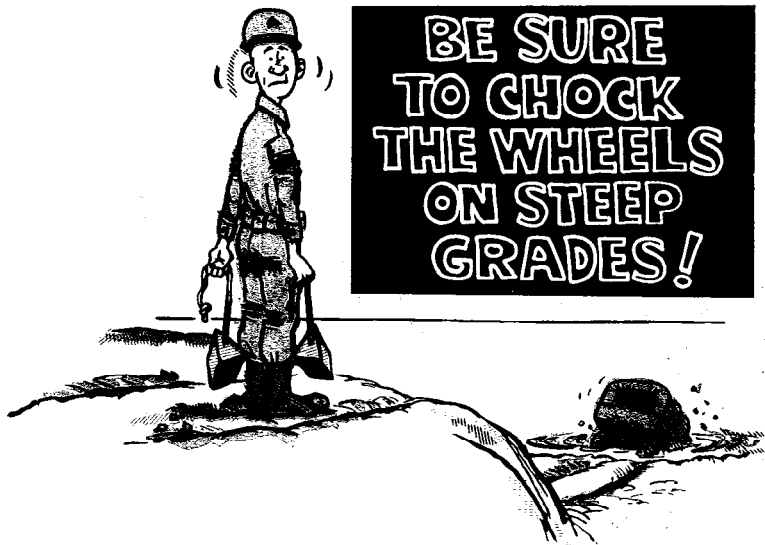

- c. To operate the service parking lights, raise the light switch lower right lever and simultaneously move the upper lever to SERVICE DRIVE. Move the lower left lever to PARK.

2-10. Use of the Transfer.

a. General. The transfer may be operated in high range with front axle engaged or disengaged. When front axle is engaged, torque is divided equally between front and rear axles. When transfer is in low range, front axle is also engaged, preventing excessive strain on rear axle.

CAUTION: Front axle should be engaged only in off-the-road operation, on slippery roads, steep grades, or during hard pulling. Disengage front axle when operating on average roads under normal conditions, to prevent excessive tire wear.

b. High Range (2-Wheel Drive). For operation on a smooth level highway, place transfer in high range and be sure front axle is disengaged.

(1) With the vehicle stopped, depress clutch pedal and place transmission gearshift lever in first gear.

(2) Move the transfer shift control lever and transfer declutch control lever to forward positions.

Note. If difficulty is encountered in shifting control lever, release clutch pedal slightly to allow gears to mesh.

(3) With transfer engaged, proceed with driving operations as in paragraph 2-6.

c. High Range (4-Wheel Drive). To engage front axle while operating in high range:

(1) Stop the vehicle.

(2) Depress clutch pedal, and pull declutch control lever back to engaged position.

(3) Proceed with driving operations as in paragraph 2-6.

CAUTION: When terrain conditions indicate need for front wheel drive, shift transfer before encountering obstacle. Do not attempt to engage front wheel drive, or change driving range, while rear wheels are spinning. Push in clutch, idle the engine and then shift transfer levers.

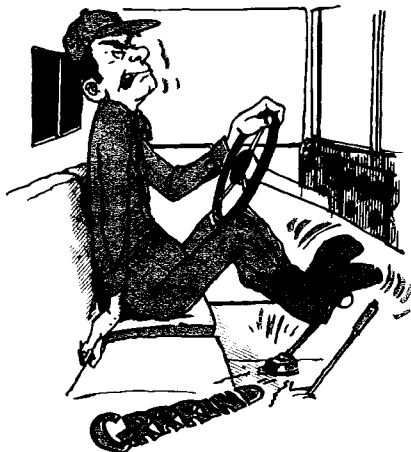

d. Low Range (4-Wheel Drive). For transporting heavy loads over rough terrain or up steep grades, or for operating through mud, sand, snow, or ice, use low range.

(1) Stop the vehicle.

(2) Depress clutch pedal, place transmission gearshift lever in first gear and pull transfer shift control lever back to low range position. As shift lever is placed in low range position, it engages transfer declutch control lever, moving it to engaged position.

Note. If difficulty is encountered in operating shift control lever, release clutch pedal slightly to permit gears to mesh.

(3) With transfer engaged, proceed with driving operations as in paragraph 2-6, above.

2-11. Driving on Steep Grades.

a. When driving up a steep grade, shift transmission to next lower gear to prevent excessive engine laboring or stalling. If it becomes necessary to shift to a still lower gear with the vehicle in motion:

(1) Depress clutch pedal and move gear shift lever to neutral.

(2) Quickly release clutch pedal and, at the same time accelerate engine.

(3) Depress clutch pedal, release accelerator and shift lever to next lower gear position.

(4) Release clutch pedal, accelerating engine, as necessary, to prevent loss of speed.

Note. The entire "double clutching" procedure must be accomplished quickly and smoothly to be effective.

b. When driving down long, steep grades, shift transmission to a lower gear to permit engine to assist in slowing the vehicle. Gear selected will be determined by length and steepness of grade.. Usually second speed gear is preferred to any other.

CAUTION: Avoid constant and severe application of the brakes to prevent burning or excessive wear of brake linings.

2-12. Operating Ambulance Truck.

a. General. As the operator, you are responsible for reporting any deficiencies in the ambulance truck. This is especially essential for assemblies and equipment related to the patient's compartment such as surgical light, ventilating blowers, partition door ventilator, door sealing, body (floor) condition, patient's compartment heater, and heater and vehicle exhausts.

b. Operation of Heater. Patient's compartment heater should not be operated without allowing sufficient entry of fresh air. Open ventilator in partition door or open partition door during operation.

c. Operation of Ventilator Blowers. When operating one or both ventilating blowers, keep partition door ventilator open or open the partition door.

d. Parking Ambulance. When vehicle engine and/or patient's compartment heater is operating in a parked vehicle, position vehicle so that exhausts will not be driven onto or under the vehicle. Generally face the left side of the vehicle into the wind.

WARNING: Carbon monoxide is a colorless, odorless, deadly poisonous gas which, when breathed, deprives the body of oxygen and causes suffocation. Permanent brain damage or death can result from severe exposure. It occurs in exhaust fumes of fuel-burning heaters and internal combustion engines, and becomes dangerously concentrated under conditions of inadequate ventilation. Do not operate heater or engine in an enclosed area unless it is adequately ventilated. Be alert at all times during vehicle operation for exhaust odors and exposure symptoms such as headache, dizziness, loss of muscular control, apparent drowsiness, and/or coma. If any are present, immediately ventilate personnel compartments. If symptoms persist, remove affected personnel from vehicle, expose to fresh air and keep them warm. **DO NOT PERMIT PHYSICAL EXERCISE.** If necessary, administer artificial respiration.

Section II - OPERATION OF AUXILIARY EQUIPMENT

2-13. Top Operation (M37 and M201).

a. Raising and Lowering Windshield.

(1) Vehicles are equipped with fold-down windshield assemblies. Windshield may be folded forward onto hood of engine compartment and secured with hold-down catches.

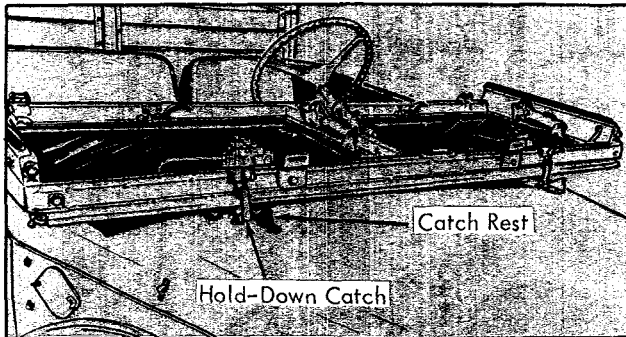

(2) To erect windshield, disengage hold-down catches from windshield frame and secure to catch rests.

(3) Raise windshield to upright position and engage windshield support frame right and left clamp handles.

(4) To lower windshield, reverse procedure in (2) and (3) above.

b. Installing Cab Top Cover.

(1) Install left and right top side rails on rear supports, and install two lockwasher screws in each side.

(2) Place J-bolt and U-bolt in each cab lock pillar and aline for installation of top side rail with rear supports.

Install rear supports. Install but do not tighten two lockwasher screws to secure each support to windshield frame. Install two lockwashers and nuts on each J-bolt and U-bolt. Tighten nuts.

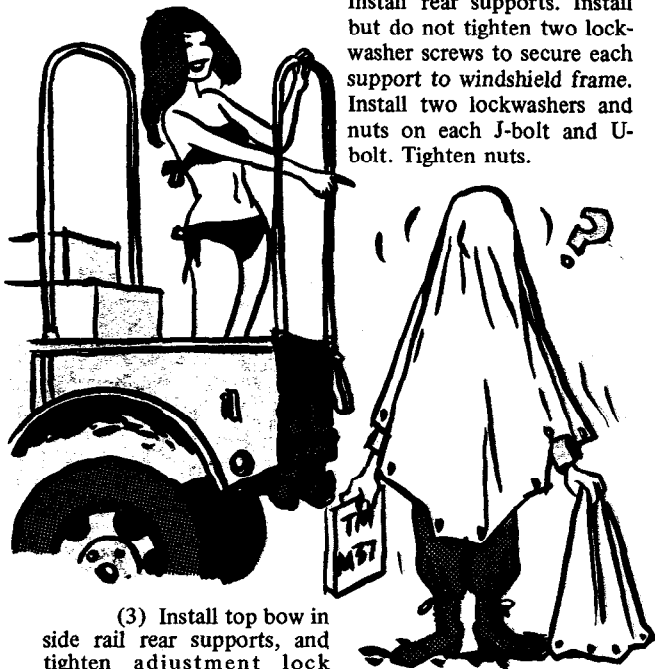

(3) Install top bow in side rail rear supports, and tighten adjustment lock screws.

(4) Check door glass alinement and adjust as necessary.

(5) Insert front of top cover in left end of retainer on windshield frame and pull cover into retainer from left to right.

(6) Insert sides of cover in upper ends of retainers on rear supports and pull cover down.

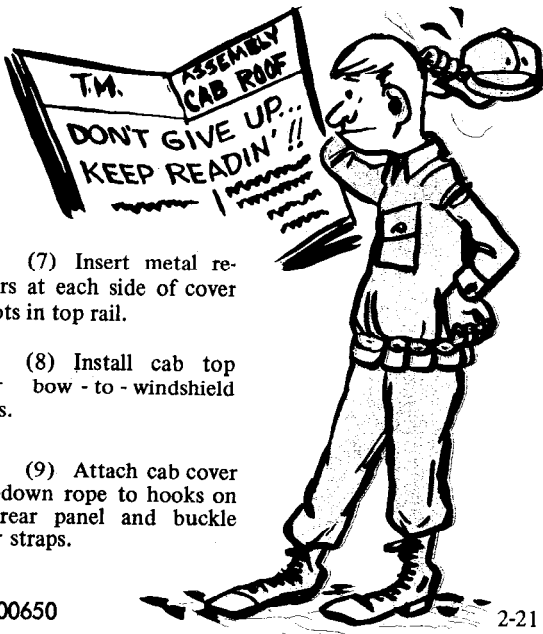
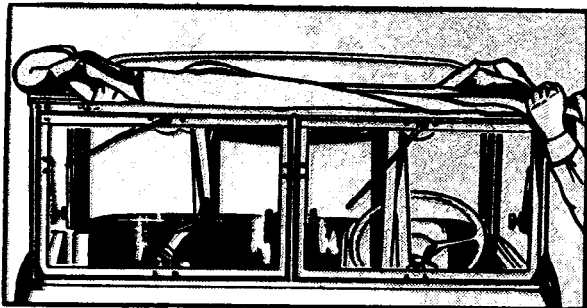

(7) Insert metal retainers at each side of cover in slots in top rail.

(8) Install cab top cover bow - to - windshield straps.

(9) Attach cab cover hold-down rope to hooks on cab rear panel and buckle cover straps.

c. Removing Cab Top Cover.

- (1) Unhook cab top cover hold-down rope from hooks on cab rear panel.
- (2) Remove cab top cover bow-to-windshield straps.

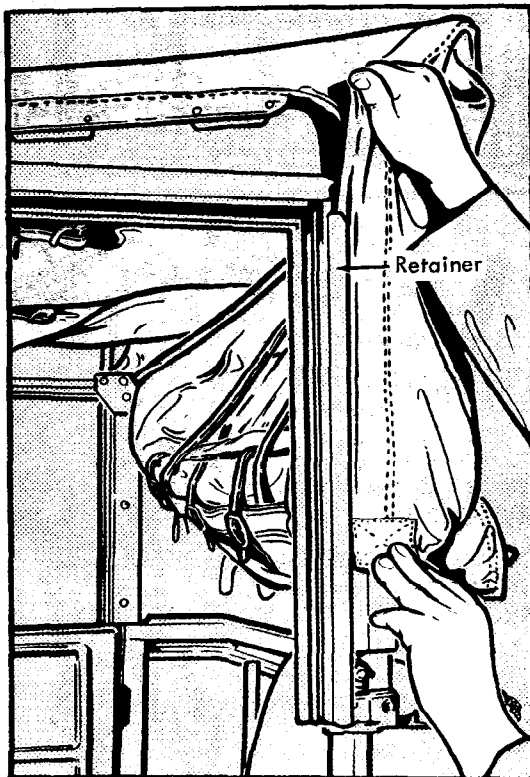

(3) Pull cover out from top side rails to disengage retainers from side rails.

(4) Pull cover up to remove it from retainers on side rail rear supports.

(5) Fold cover toward windshield and pull cover from left side of windshield support frame retainer.

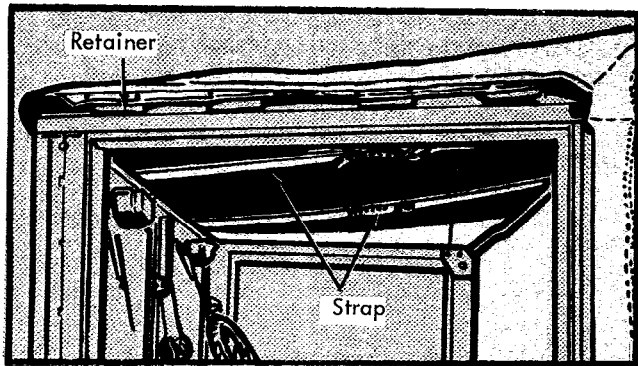

(6) Loosen upper rear support adjustment lock screws at sides, and remove top bow from side rail rear supports.

(7) Loosen nuts on J-bolt and U-bolt in each cab pillar. Remove lockwasher screws that secure each top side rail to windshield frame and remove side rails and side rail rear supports as units. Remove nuts and lockwashers from the J-bolts and U-bolts. Remove bolts.

(8) Remove lockwasher screws which secure each top side rail to rear support, and separate the two.

d. Installing Cargo Body Top Cover (M37).

(1) Install assembled bows and ridge pole on body, inserting side bows in seat back supports. Aline bolt holes in side bows with those in supports, and install carriage bolt, lockwasher, and nut for each side bow. Tighten nuts.

(2) Secure end curtains to front and rear top bows with lashing ropes, using ¼-inch rope. Attach front curtain hold-down ropes to hooks on front of side panel. Attach rear curtain hold-down ropes to hooks on tailgate.

(3) Install body cover and secure cover ropes to hooks on side panels.

e. To remove cargo body top cover, reverse above procedure.

2-14. Winch and Power-Take-Off
(On Vehicles So Equipped).

a. General. The winch, mounted at the front of your vehicle, is operated by power transmitted through the transmission and power-take-off and winch drive shaft. The winch clutch shifter handle controls engagement and disengagement of winch clutch with winch cable drum. The power-take-off shift lever controls direction of winch drum rotation when clutch shifter handle is in engaged position. A shearpin in drive shaft front universal joint prevents damage to driving mechanism if winch is overloaded. A safety brake operates on winch worm shaft to hold load in any desired position, or if shearpin breaks.

b. Controls.

(1) To operate power-take-off shift lever, raise lever lock and move shift lever to desired position. The lock is spring-loaded to hold lever in neutral position and prevent accidental winch drive shaft engagement.

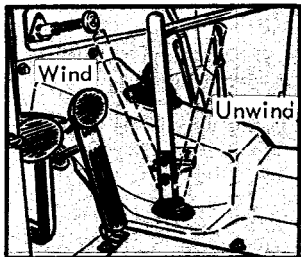
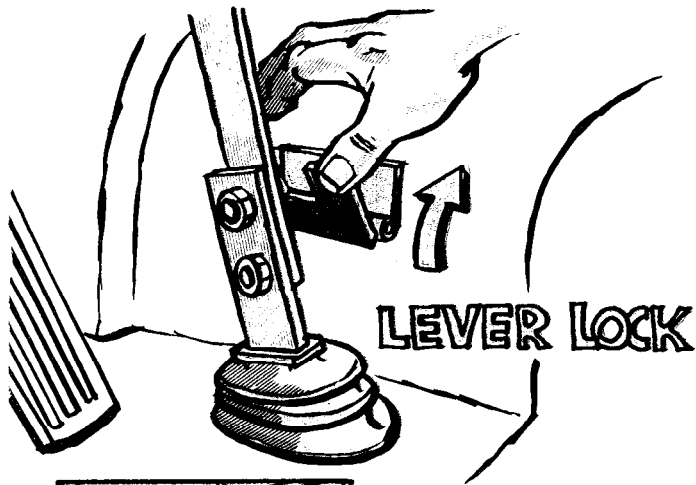

(2) To operate winch clutch shifter handle, raise handle knob to disengage the shaft from clutch indexing plate, move handle to engaged or disengaged position and release handle knob. The knob shaft spring holds handle in position on indexing plate.

c. Unwinding Cable. To unwind winch cable, move winch clutch shifter handle to disengaged position, and pull cable from drum until required length of cable has been unreeled.

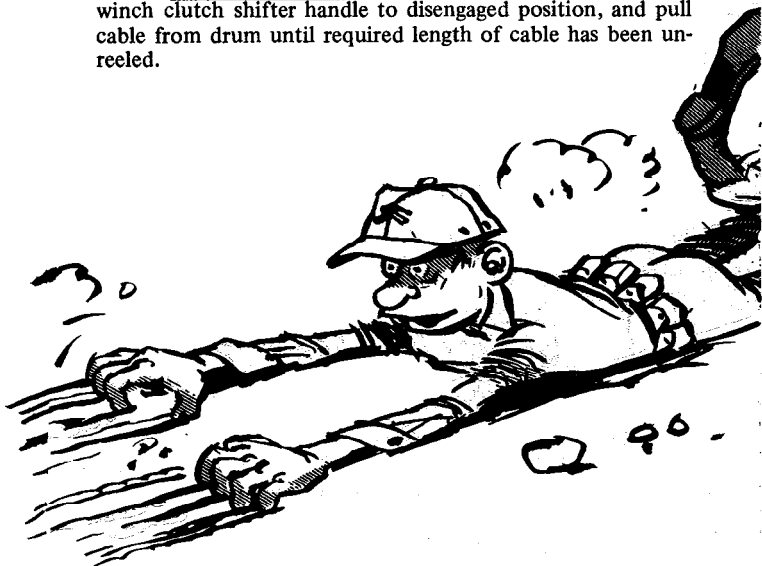

d. Unwinding Cable Under Load.

(1) Start engine and run at idle speed or slightly faster until normal operating temperature is reached.

(2) Place winch clutch shifter handle in engaged position.

(3) Apply handbrake lever.

(4) Depress clutch pedal and move power-take-off shift lever to unwind (rear) position.

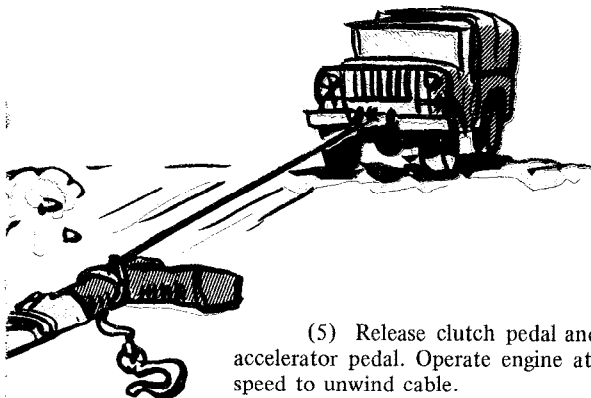

(5) Release clutch pedal and depress accelerator pedal. Operate engine at an even speed to unwind cable.

(6) To stop cable, depress clutch pedal and release accelerator pedal. The winch safety brake will hold load.

e. Winding Cable. Procedure for winding cable is the same as for unwinding under load, with the exception of d(4) above. To wind cable, place power-take-off shift lever in

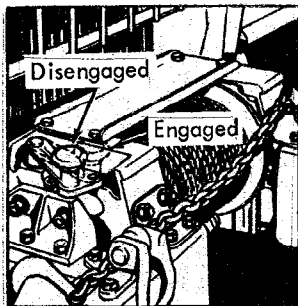

wind (forward) position. If all the cable has been unreeled from drum, guide cable as it winds to keep first layer of coils as close together as possible, thus preventing next layer from pressing in between coils of preceding layer. Cable should be wound under load to ensure even winding on drum.

f. Securing Winch Chain.

(1) After winding cable on drum, route winch chain assembly under and over left frame member, extend across front of winch and hook over right gusset.

(2) After chain assembly has been secured, place clutch shifter handle in the engaged position to prevent free spooling of drum.

CAUTION: Do not wind the cable too far, as serious damage may result if it is wound beyond the thimble that attaches chain to cable.

g. Maintenance.

(1) After each use, clean and oil cable with new engine oil or OE.

(2) Weekly, if cable has not been used, coat outer coils.

(3) Monthly, unwind entire cable, clean and oil.

(4) Semiannually, if cable is not frequently used, unwind entire cable, clean and soak, by means of a brush, with PL-S (special). Wipe off excess and coat cable with CW. Coat winch drum with CW before rewinding cable.

2-15. Litter Racks (M43).

a. Description. Two litter racks in the patient compartment may be raised or lowered. With both racks in the raised position, four litter patients can be transported. With the litter racks and seat back cushions in the lower position, six seated patients can be accommodated. Safety and litter hold-down straps are provided.

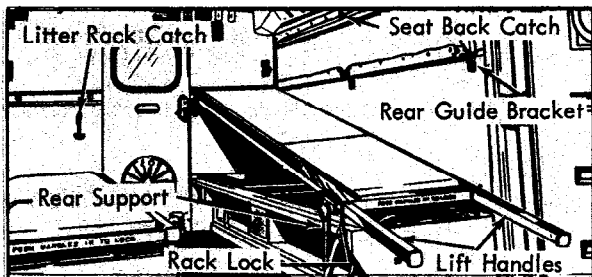

b. Raising Litter Rack.

(1) Raise seat back cushion and secure with seat back catch.

(2) Pull out both litter rack lift handles.

(3) Raise front end of litter rack and engage rack pins in partition openings.

(4) Raise rear of litter rack and engage with rear guide bracket.

(5) Push both lift handles in to lock rack in raised position.

Note. If the litter rack supports are not in the fully raised position, the lift handles cannot be pushed in.

(6) Engage litter rack catch.

c. Lowering Litter Rack.

(1) The litter rack catch must be disengaged from the catch bracket to provide clearance for lowering the rack.

(2) Pull out both litter rack lift handles to disengage the litter rack locks.

(3) Push both rack supports forward and lower rear of rack.

(4) Lift front end of rack from partition and lower rack.

(5) Push the two lift handles in.

2-16. Ventilator Blowers (M43).

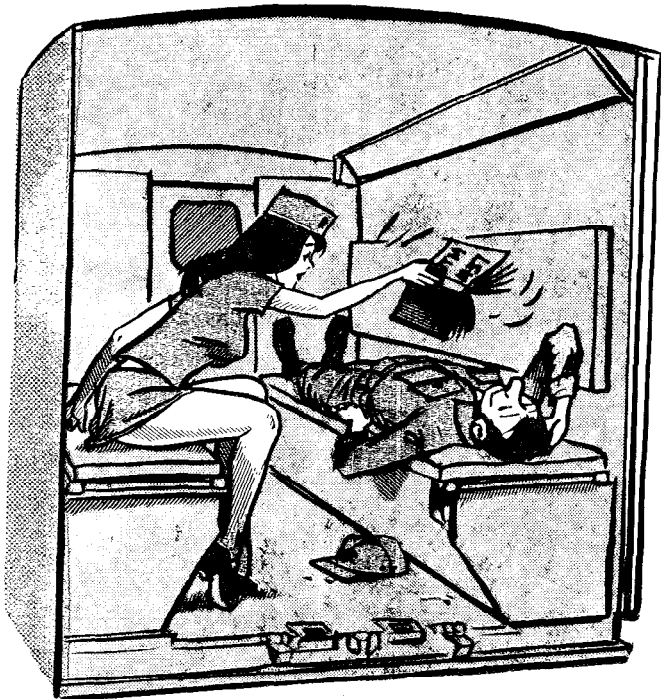

a. General. Two ventilator blowers are provided to draw hot air or odors from patient compartment. Each blower motor is controlled by a switch. Openings in blower ducts are controlled by ventilator blower control valve handles.

b. Operation.

(1) To operate either blower, turn the blower switch to ON.

(2) Turn ventilator blower control valve handles to desired position to regulate valve. When valve handles are in horizontal position, valves are fully open; when handles are in vertical position, valves are fully closed.

2-17. Personnel Heater (M43).

a. General. Personnel heater operation in patient compartment is controlled by heater control. Compartment temperature is regulated by personnel heater thermostat.

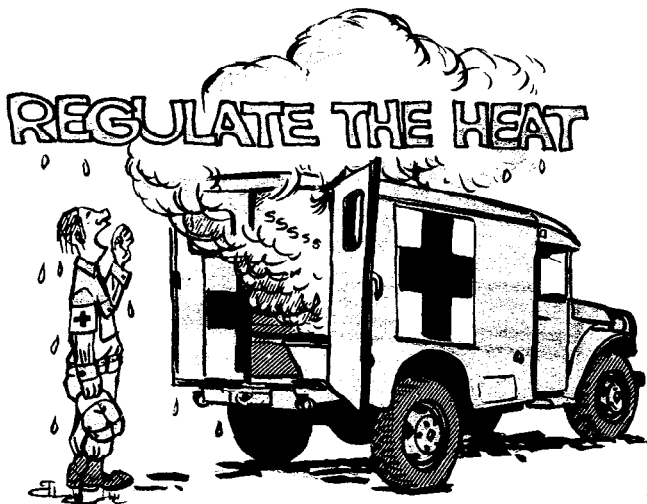

b. Operation. Specific instructions for operating heater and thermostat are provided on personnel heater operating instruction plate. To deflect stream of warm air from heater outlet, move heat deflector handle located under right litter rack.

2-18. Ladder Rack Lock Control (M201).

The ladder rack lock control secures ladders and other equipment on the rack. To open lock, move control forward. To close lock, move control toward rear.

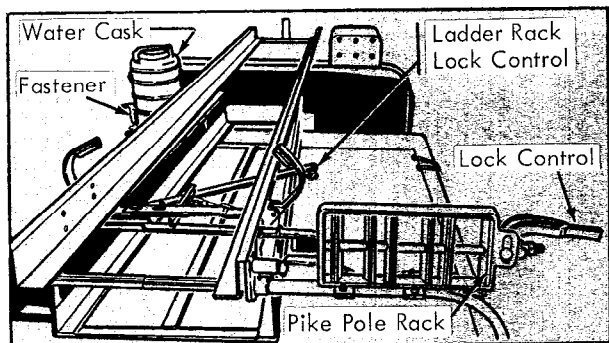

2-19. Pole Rack Lock Control (M201).

The pole rack lock secures pike poles during transit. To open rack, pull control outward as shown. To close rack, move control down.

2-20. Water Cask Fasteners (M201).

Two spring-loaded fasteners secure the water cask in position. To engage or disengage fasteners, pull against spring tension and hook or unhook from fastener catches.

2-21. PR Reel (M201). (Refer to TM 11-3895-201-13P.)

a. General. The PR reel is supported in a frame mounted on three support brackets (1, 5, and 6) in the truck body. The expansion lock pin (2) secures the outer section of the reel in one of four positions on the reel shaft to accommodate different sizes of cable or varying loads on the reel. Reel braking is controlled by the brake wing nut (4). The support bracket lock lever (7) locks the reel frame in the support brackets.

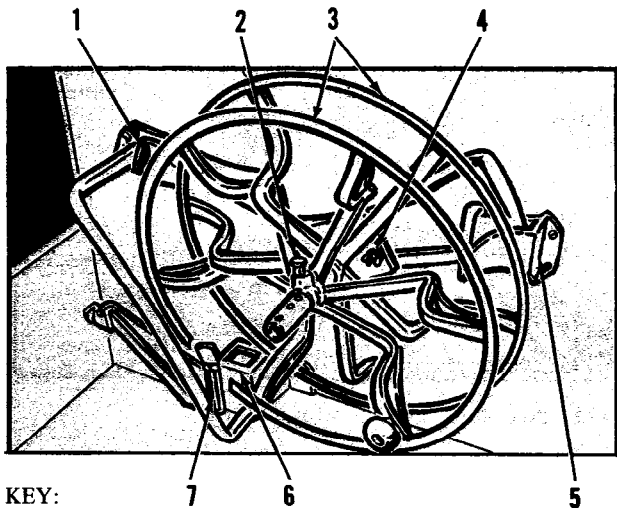

KEY:

- | | |
|-------------------------------|--------------------------------|
| 1. Upper rear support bracket | 5. Upper front support bracket |
| 2. Expansion lock pin | 6. Lower support bracket |
| 3. PR reel | 7. Lock lever |
| 4. Brake wing nut | |

b. Removal. Move support bracket lock lever (7) upward to unlocked position. Lift PR reel (3) from brackets.

c. Installation. With support bracket lock lever (7) in unlocked position, mount PR reel (3) in three support brackets. Pull lock lever down to locked position.

2-22. Spare Wheel Stowage.

a. The hinged-type spare wheel carrier can be unlocked from either the inside or outside, thus providing full use of the cab left door.

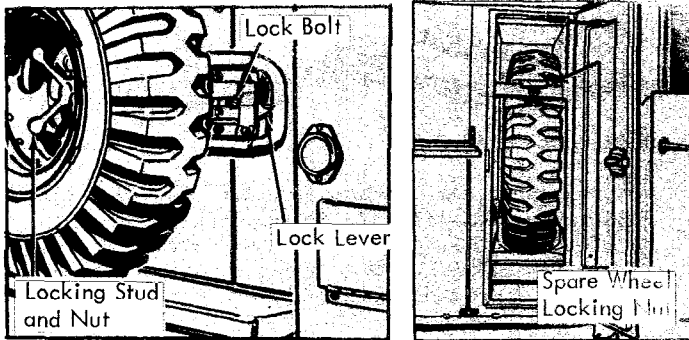

(1) To open the door from outside, press lock lever down, swing carrier out, and open door.

(2) To open door from inside, raise inside lock lever to unlocked position, unlatch door, and push both door and spare wheel carrier open.

b. The M201 telephone maintenance truck provides spare wheel stowage in the right side front compartment of the body.



2-23. Fire Extinguisher.

a. Location. On the Cargo Truck M37 and Telephone Maintenance Truck M201, the fire extinguisher is mounted in a bracket on the right cowl inside panel of the cab. On the Ambulance Truck M43, it is to the rear of the right door inside the driver's compartment.

b. Operation. Remove extinguisher from bracket. Turn handle counterclockwise to the released position and work with a pumping motion. For best results, direct discharge toward the base of the flames. To extinguish burning liquid in a container, direct discharge against inside of container just above burning liquid.

c. Maintenance. Each time extinguisher is used, refill with fire extinguisher liquid through filler plug opening. After filling, turn handle to locked position. Keep extinguisher clean, fully charged, and properly stowed.

Section III- OPERATION UNDER UNUSUAL CONDITIONS

2-24. General.

a. In addition to the operating procedures described for usual conditions, special instructions for operating and servicing this vehicle under unusual conditions are contained in this section. It is imperative that approved practices and precautions be followed.

b. In addition to normal preventive maintenance service, special care in cleaning and lubrication must be observed where extremes of temperature, humidity, and terrain conditions are present or anticipated. Refer to Lubrication Order LO 9-2320-212-12 for lubrication under unusual conditions; refer to table in Chapter 3, Section II, for preventive-maintenance checks and maintenance procedures to be performed.

c. When chronic failure of vehicle results from subjection to extreme conditions, report the condition to your supervisor and record on DA Form 2407.

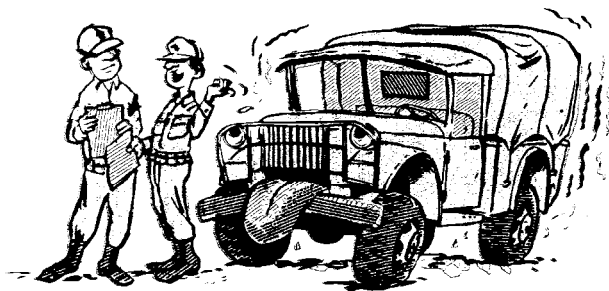

2-25. Extreme-Cold Weather Conditions.

a. General.

(1) Extensive preparation of materiel scheduled for operation in extreme-cold weather is necessary. Lubricants thicken, batteries freeze or cannot furnish sufficient current for starting, insulation cracks causing short circuits, fuel will not vaporize properly for starting, and materials become brittle, and easily damaged.



(2) In the field, maintenance must be undertaken under the most difficult of conditions. Bare hands stick to cold metal. Fuel in contact with the hands results in supercooling due to evaporation, and the hands can be painfully frozen in a matter of minutes. Engine oils, except subzero grade, are unpourable at temperatures below -40°F . Ordinary greases become as solid as cold butter. These difficulties increase the time required to perform maintenance. At temperatures below -40°F ., maintenance requires up to five times the normal amount of time. The time required to warm up a vehicle so that it is operable at temperatures as low as -50°F . may approach 2 hours. Vehicles in poor mechanical condition probably will not start at all, or only after many hours of laborious maintenance and heating. Complete winterization, diligent maintenance, and well-trained crews are the key to efficient arctic-winter operations.



CAUTION: It is imperative that the approved practices and precautions be followed. TM 9-207 contains general information which is specifically applicable to this vehicle as well as to all other ordnance material. This information must be considered as an essential part of this manual, not merely as an explanatory supplement to it.

b. Winterization Equipment. Special equipment is provided for your vehicle when protection against extreme-cold weather (0° to -65°F.) is required. This equipment is issued as specific kits.

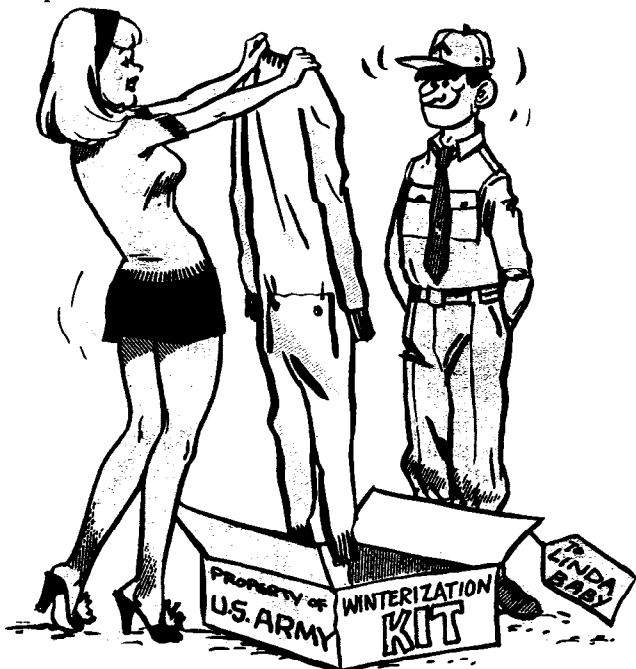

c. Fuels, Lubricants, and Antifreeze Compounds.

(1) Operation of equipment at arctic temperatures depends to a great extent on the condition of fuels, lubricants, and antifreeze compounds used. Immediate effects of careless handling or use are not always apparent, but any deviation from proper procedures invites equipment failure at the least expected time.

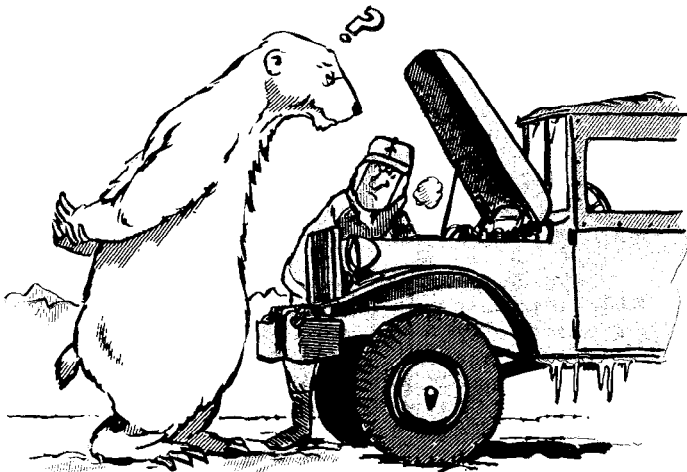

(2) In arctic operations, contamination with moisture is a source of many difficulties. Moisture can be the result of snow getting into containers, condensation due to “breathing” of a partially filled container, or moisture condensed from warm air when a partially filled container is brought outdoors from room temperature. Other impurities will also contaminate fuels and lubricants so their usefulness is impaired.

2-26. Extreme-Cold Weather Operation.

a. General.

(1) As operator you must always be on the alert for indications of the effect of cold weather on your vehicle. Your vehicle must be kept in the best mechanical condition possible; otherwise, it will not operate properly.

(2) Carbon monoxide poisoning presents an added hazard. Poisoning is the result of inhaling the exhaust fumes of the vehicle and usually results in death. To avoid it, never sleep in the cab of your vehicle with the engine or heater running and, whenever the heater is used while driving, leave a window open slightly. Inspect the vehicle exhaust manifold, muffler, and tailpipe for serviceability and tightness daily. Never leave the engine running while working on the vehicle in a closed building.

(3) Be very cautious when starting or driving your vehicle after an extended shutdown. Congealed lubricants may cause part failure. Tires may be frozen to the ground or frozen in the shape of a flat spot while under-inflated. One or more brake shoes may be frozen fast and require preheating. You must take proper measures for all such conditions to prevent failure of your vehicle.

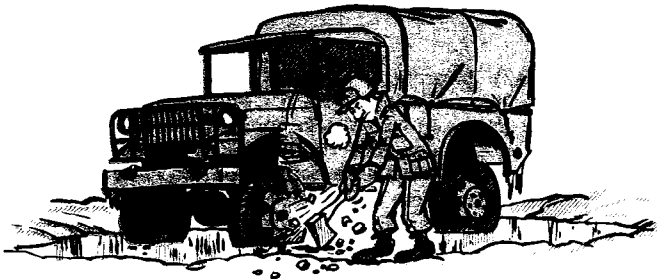

(4) After warming up the engine thoroughly, drive vehicle slowly about 100 yards in first gear. This should warm gears and tires to a point where normal operation can be expected.

(5) Frequently note instrument readings. If instruments consistently deviate from normal, stop the vehicle and investigate.

(6) A special engine thermostat provided in the arctic winterization kit opens at 180°F., and at this temperature, the engine will give best results. If temperature gage reading consistently exceeds 200°F., adjust flap on radiator winterfront cover to admit more air.

(7) Vehicles equipped with mud and snow tires will slide more on icy road surfaces than those with commercial tread. Mud and snow treads are most effective on roads covered with loosely packed snow.

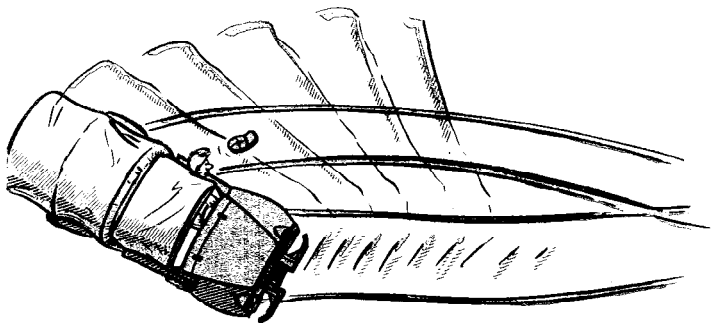

AVOID SKIDS ON SLICK ICE

(8) Chains give a good bite in snow or mud, but slide and slip on ice or packed snow.

(9) Sand, cinders, or dirt scattered on icy road surfaces give more traction than chains.

(10) Fresh snow may conceal an icy road surface.

(11) Although snow or ice may be melting on roads, it may remain solidly packed or frozen on bridges.

b. Driving on Icy Roads.

(1) Start in second or third gear rather than low, engage clutch gradually, and accelerate no more than is necessary to keep from stalling.

(2) Avoid quick acceleration on slick roads – it will probably throw you into a skid.

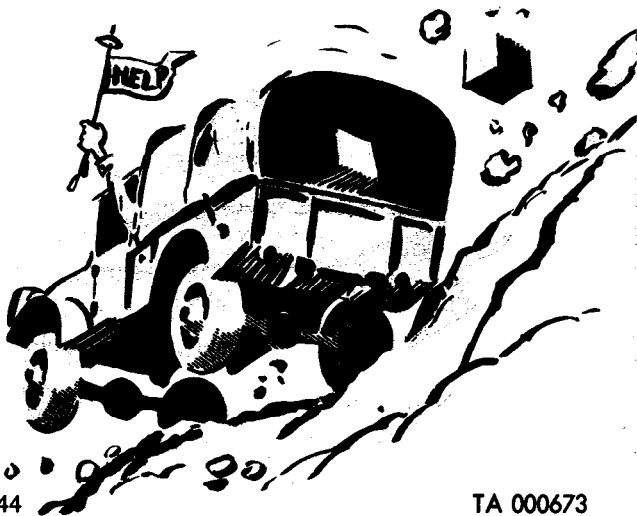



(3) Drive at reduced speeds so that you can stop quicker.

(4) Give turn signals sooner than usual; this gives other drivers more time to control their vehicles.

(5) Pump your brakes to flash an early warning of intention to stop.

(6) Maintain double the normal distance from the vehicle ahead.

(7) Good all around visibility is the first requirement of safe driving. Keep windshields, windows, mirrors, headlights, stop lights, and body lights clean and free of snow and ice. If defrosters are not available, windshields may be kept clean by using the windshield wiper, by wedging the rear of the hood open to provide a vent through which motor heat is directed to the windshield, or by thorough ventilation inside the vehicle. Windshields of vehicles parked in open lots may be covered with cardboard or canvas to prevent overnight frosting.

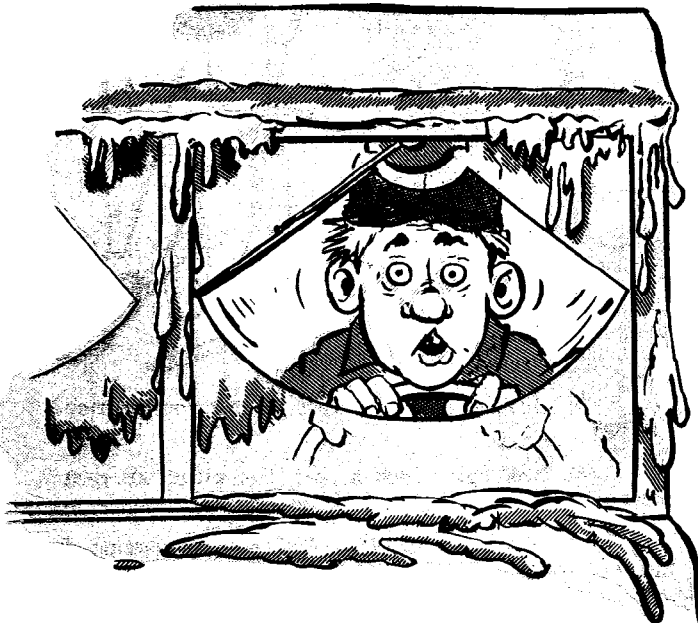

(8) Descend moderate grades in the gear normally used to climb the same grade. On steep or very slippery grades, use at least one gear lower.

(9) Under conditions of poor visibility, use low beam headlights to warn other drivers of your position. If visibility is zero, stop, park off the roadway, and wait for conditions to improve. If absolutely necessary to continue, have an assistant driver or passenger walk in front of the vehicle as a guide.

(10) Avoid vehicle tracks, rocks, and other objects which might throw the vehicle sideways and start a skid.

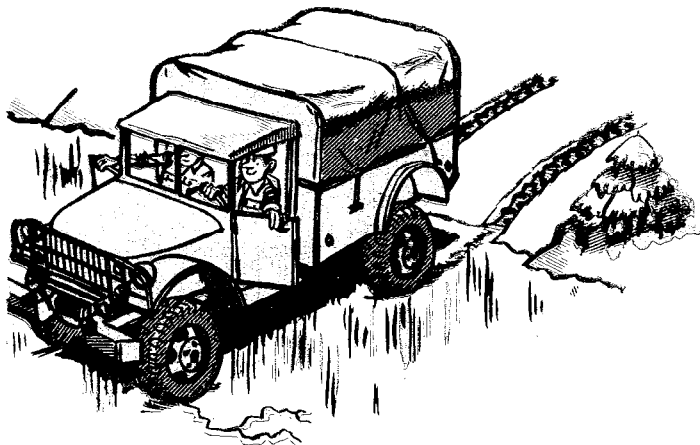

(11) Keep cab door open when crossing frozen streams; you may need to leave in a hurry if the ice thins.

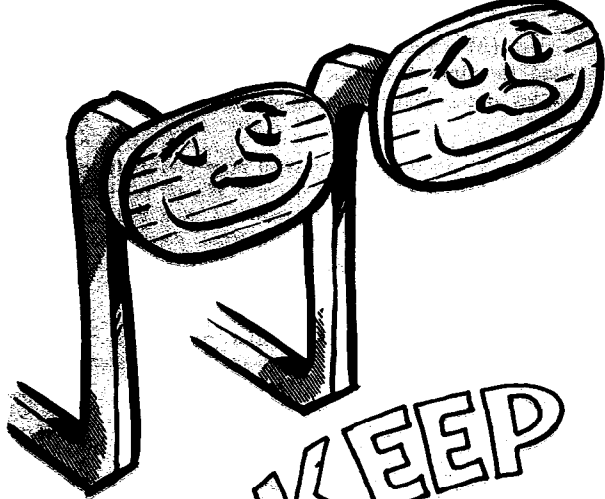

**KEEP
'EM
DRY**

(12) After driving through slush or water, test your brakes while moving at a reduced speed. If your brakes are not operating normally, continue at a slow speed while maintaining a moderate pressure on your brake pedal to create a slight drag. The heat generated by the friction between the brake shoe and brake drum will dry your brakes.

(13) On roads which slope towards the side ditches, it may be helpful to straddle the center or crown in order to avoid sliding to the side. Watch carefully for approaching traffic.

(14) If uncertain about a difficult stretch of road, stop and inspect it carefully before going across. Select a gear that will get you through. If following a vehicle, wait until it crosses; it may be necessary for you to render assistance if it gets stuck.

(15) To drive through a difficult stretch, shift down before entering it, and keep moving. If wheels begin to spin, disengage clutch at once, back up and try again.



c. Stopping.

- (1) Gradually ease up on gas. Leave vehicle in gear.
- (2) Apply brakes intermittently and lightly; use engine compression as much as possible to assist braking.
- (3) Disengage clutch at last possible moment to prevent stalling.
- (4) Avoid sudden braking on slick roads, as it will throw you into a skid.

d. At Halt or Parking.

(1) When halted for short shutdown periods, park your vehicle in a sheltered spot out of the wind. If no shelter is available, park so that the vehicle does not face into the wind.

(2) Place brush, boards, or other suitable material beneath wheels when parking for extended periods on wet, slushy, or muddy surfaces, to prevent tires from freezing to the ground or from being "pocketed" in ice.

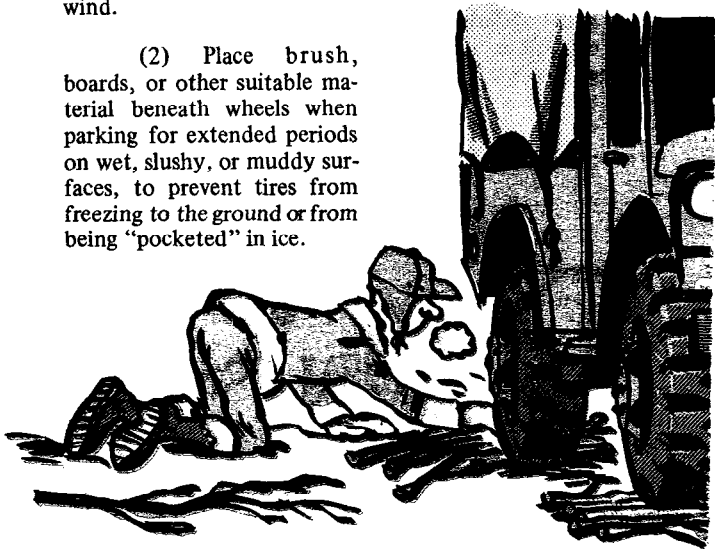

(3) When preparing your vehicle for shutdown periods, place control levers in neutral to prevent them from freezing in an engaged position.

(4) Do not set handbrake, as it may freeze in place. Chock your wheels instead.

(5) Refuel immediately in order to reduce condensation in the fuel tank. Prior to refueling, open fuel tank drain cock and drain off any accumulated water.

(6) Immediately after engine shutdown, start the power plant heater and check to be sure it operates effectively. The heater should avoid the necessity of removing the batteries to warm storage, and is designed to operate unattended during overnight stops.

(7) If no power plant heater is present, the batteries should be removed and stored in a warm place. However, it is unnecessary to drain engine oil (OES), as it will remain fluid even though unheated.



(8) Clean all parts of the vehicle of snow, ice, and mud as soon as possible after operation. Cover and shield the vehicle, but keep the ends of canvas tarpaulins off the ground to prevent them from freezing to the ground.

(9) When drain cocks have been opened to remove liquid from the cooling system, inspect both drain cocks to be sure they are not obstructed. If the drain cocks are obstructed by foreign material, remove the two cocks. This is particularly important before leaving a vehicle that has had the engine drained to protect the block from freezing. Draining of an engine cooling system to prevent freezing will be done only when no approved antifreeze solution is available.

2-27. Extreme-Hot Weather Operation.

a. General. Operation of your vehicle at high speeds or under long hard pulls in low gear ratios on steep grades or in soft terrain may cause the engine to overheat. Be alert for overheating, and halt the vehicle for a cooling off period whenever necessary and the tactical situation permits. Frequently inspect and service cooling system, oil filter, and air cleaner. If the engine temperature consistently rises above 200°F., look for dust, sand, or insects in radiator fins and clean out any accumulation. Flush cooling system if necessary.

WARNING: Extreme care must be exercised in removing radiator filler cap when temperature gage reads above 180°F.

**STOP AND COOL THE
VEHICLE ...
WHENEVER IT IS
TACTICAL
AND PRACTICAL**

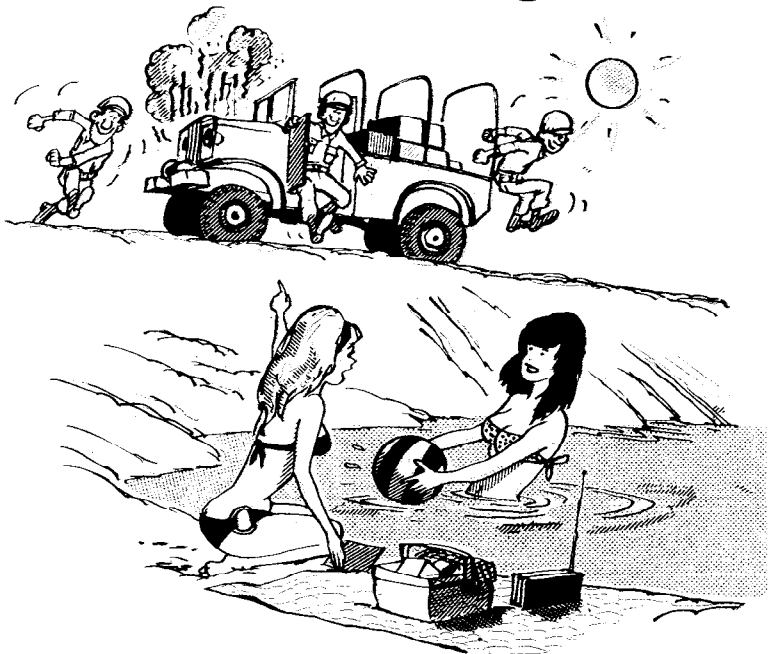

b. At Halt or Parking.

(1) Do not park the vehicle in the sun for long periods, as the heat and sunlight will shorten the life of all rubber, fabric, plastics, and paint used in or on the vehicle. When practical, park under cover to protect vehicle from sun, sand, and dust.

(2) Cover inactive vehicle with tarpaulins if no other suitable shelter is available. Where entire vehicle cannot be covered, protect window glass against etching by sand, and protect engine compartment against entry of sand.

(3) Check level of electrolyte in battery cells daily and replenish, if necessary. If distilled water is not available, clean drinking water may be used.

2-28. Operation on Unusual Terrain.

a. General.

(1) Operation on snow or ice-covered terrain or in deep mud requires use of tire chains on the driving wheels. Tire chains must be installed in pairs (front and rear).

CAUTION: Attempted operation with only one wheel of a driving axle equipped with a tire chain may result in serious damage to the tire and/or power train.

(2) Select a gear ratio low enough to move vehicle steadily and without imposing undue driving strain on engine and power train. However, racing of the engine for extended periods must be avoided.

CAUTION: Avoid excessive clutch slippage.

(3) When additional traction is needed, such as on ice, snow, mud, or difficult terrain, engage front wheel drive.

(4) You must know at all times the position in which the front wheels are steering, as the vehicle may travel straight ahead even though the wheels are cramped right or left. This ploughing action may cause the vehicle to stall, or suddenly veer to right or left.

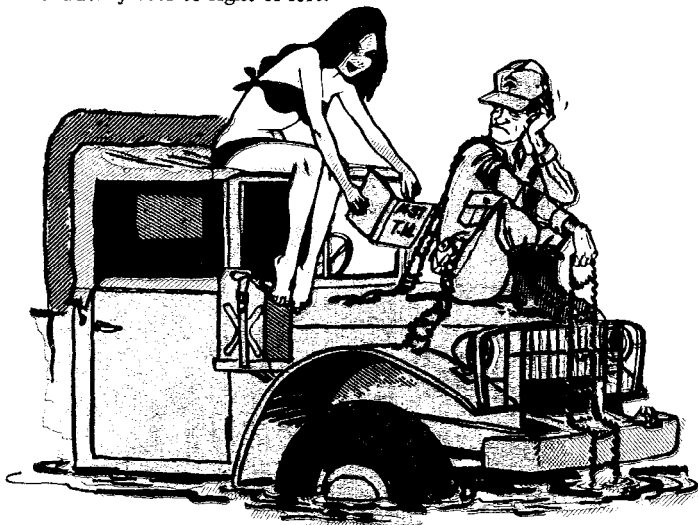

Note. A piece of string or friction tape attached to the top of the steering wheel will show you whether the front wheels are “ploughing.”

(5) If one or more wheels become mired or begin to spin, it may be necessary for the vehicle to be winched or towed by a companion vehicle, or it may be necessary to jack up the mired wheel and insert planking or matting beneath it.

(6) Lowering tire pressure to travel over sand, ice, mud, and snow will help to increase traction if tire chains are not available.

CAUTION: Do not reduce tire pressure to the extent that tire damage will result.

(7) Restore to recommended tire pressure as soon as possible after emergency. Refer to vehicle data plates and table on page 1-4.

(8) Operation in sand requires daily cleaning of air cleaners and fuel and oil filters. Engine grilles and other exposed vents should be covered with cloth.

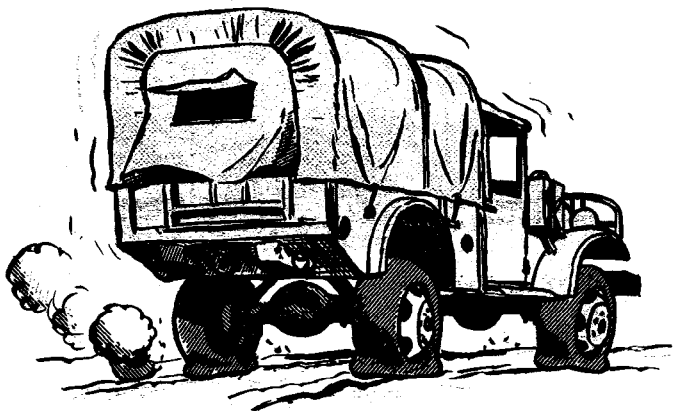

KEEP TIRES INFLATED

(9) High-altitude operation requires careful maintenance of the cooling system, as the boiling point of the coolant drops in proportion to the altitude reached. Keep a close watch on engine temperature during the summer months.

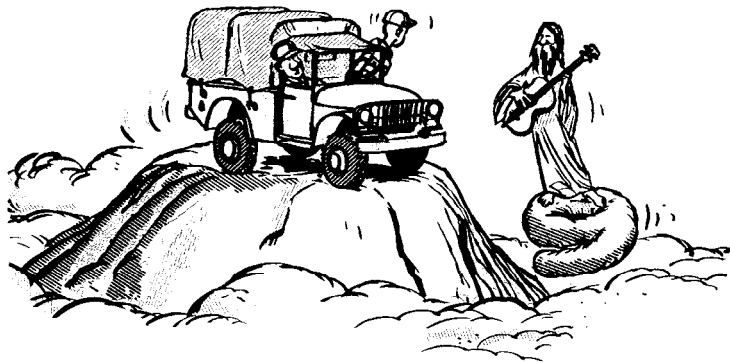

WARNING: Extreme care must be exercised in removing radiator filler cap when temperature gage reads above 180°F.

(10) Thorough cleaning and lubrication of all parts affected must be accomplished as soon as possible after operation in mud, particularly when a sea of liquid mud has been traversed. Clean radiator fins and interior of engine compartment.

(11) Clean, oil, and stow tire chains in vehicle after use.

b. Crossing Ditches, Gullies, and Ravines.

(1) Ditches. You can easily cross shallow ditches by shifting into low gear and proceeding slowly. Enter the ditch at an angle so that one wheel leaves the ditch as the other wheel on the same axle enters it. In crossing deep ditches, use the lowest forward gear and front wheel drive. When you reach the bottom, accelerate the motor enough to keep rolling as you go up the other side. If the ditch is deep and has very steep sides, you may have to cut away the tops of the banks before attempting to cross.

**LOW
AND
SLOW**

(2) Gullies and Ravines. Gullies and ravines are natural formations caused by running water. Look these formations over carefully before crossing, in order to find a place to cross and to insure that your vehicle can get across. Be sure to examine both banks. Your vehicle approach should be made slowly, in low gear, and at a right angle to the edge. Using the footbrake, ease front wheels into gully, being careful not to have them strike the bottom at the same time. Bring your engine up to normal operating speed as your wheels hit the bottom, accelerating enough to climb as your front wheels touch the opposite bank.

c. Driving Through Woods and Over Rocky Terrain.

(1) Woods. Woods help to conceal you and your vehicle from air observation, but they present certain problems. Fairly open woods with trees at least as far apart as the width of your vehicle will allow passage provided you are able to maneuver your vehicle around the trees. Use an established trail if possible. If it is necessary to drive through dense growth, center the larger saplings on the vehicle bumper. Don't plan to return on the same route, because these same saplings may stop your vehicle when braced against you. If the woods are too dense and prevent your passage, drive as closely as possible to their edges, using shadows as concealment.

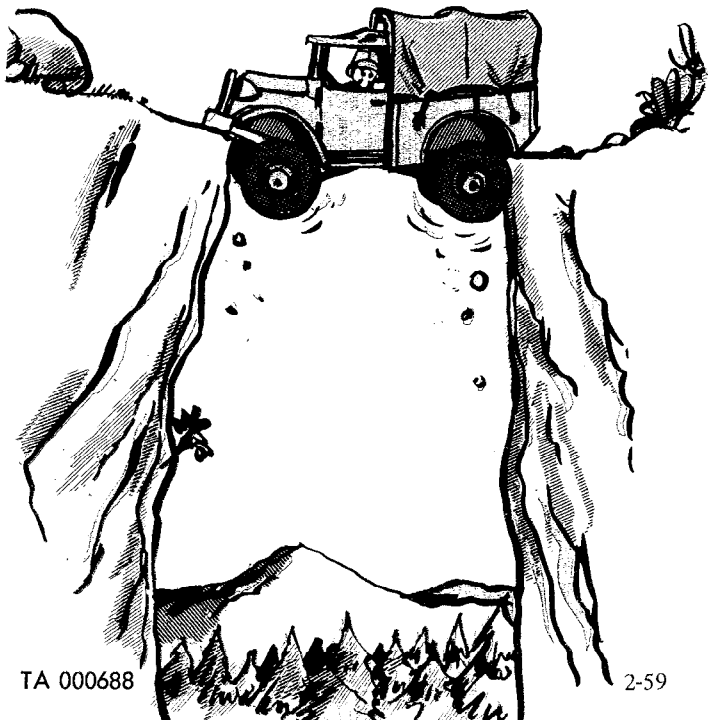

(2) Stumps. A high tree stump, if straddled, can cause serious damage to the axles and other low parts of your vehicle. Moreover, tires are injured by stumps. Drive with caution.

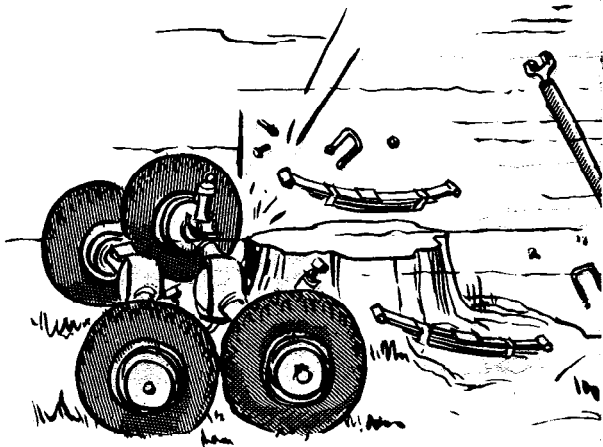

(3) Low Limbs. When you drive through wooded country, whether on country roads or across the country, low-hanging limbs may break your tarp bows or rip your top. It is usually best to remove the canvas top and the bows for field operation. Survey the route to determine whether your vehicle can proceed without damage from low-hanging limbs and whether it is practicable to remove obstructing limbs.



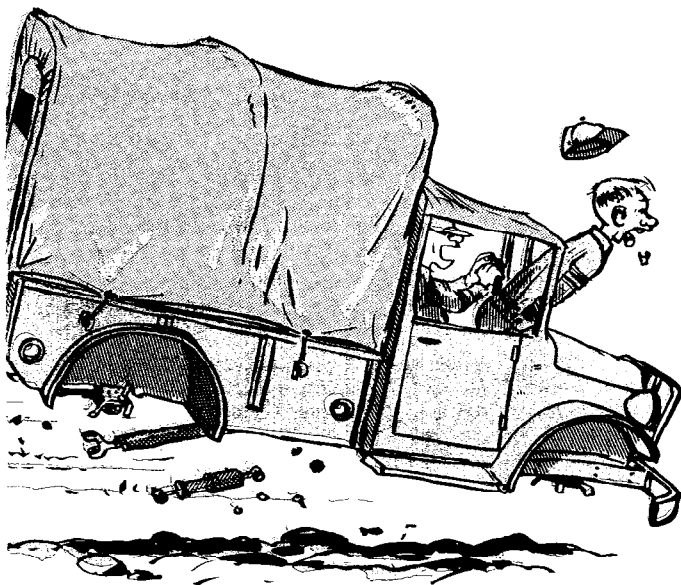

(4) Timber. Heavy timber may often be crossed by piling dirt or other material on each side and then driving over it.

(5) Rocks and Boulders. Do not attempt to straddle large boulders — they will damage axles and other low parts of your vehicle. Move very slowly. When driving in very rocky terrain, you should carry an extra spare tire if one is available, as there is greater danger of flats.

d. Driving in Mud and Swamps. Every military vehicle has enough power in lowest gear to pull out of mud, provided it gets traction. Try to pull out slowly in low gear or low range. Traction can be increased by placing boards, brush, or similar material under the vehicle's wheels. Engage front wheel drive before entering mud area.

(1) Select the gear that will get you through; roll onto the soft area at a medium speed for the selected gear; and carefully maintain a steady throttle until you reach solid ground.

(2) If you are stopped by mud rolling up in front of your wheels, you may have to back off and hit it again with regained momentum. Under most conditions this technique requires prompt action; otherwise, the mud will fill the tracks behind your wheels and slow or stop your backing. This technique requires solid footing within the reach of your vehicle.

(3) If you get stuck, try to pull out slowly in low gear. If you can't pull out, and brush or boards do not provide the traction you require, get another vehicle to pull you out. When other vehicles are not available and your vehicle is equipped with a winch, attach your winch cable to a tree or other solid object and pull yourself out with winch power. Don't rock your vehicle, because it will only dig in.



e. Driving in Sand.

(1) The main objective when driving in sand is to maintain movement with the least amount of strain on the vehicle, its engine, and power train.

(2) Reduce tire pressure when driving in soft sand and over dunes. This will increase the amount of tire surface in contact with the sand, to provide better flotation. However, never reduce tire pressure so low that the tire slips on the rim. When operating with reduced tire pressure, drive at low speed.

(3) Select a gear or range that will start you without clutch slippage and wheel spinning.

(3a) Engage front wheel drive.

(4) Accelerate gradually.

(5) Maintain a steady and even rate of movement.

(6) Avoid unnecessary shifting of gears.

(7) Anticipate difficult spots and attempt to bypass them.

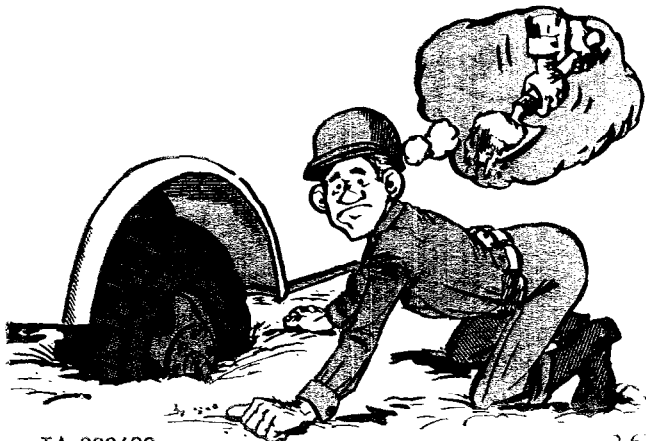

(8) To operate over a dune (hills of sand), approach the windward slope (most gradual slope) at a 90-degree angle, select the proper gear and range. This is to avoid shifting while on the slope. Maintain as much momentum as possible while going up the slope and be prepared to change direction as you reach the crest. Ride the crest if necessary to seek a safe descent route. When the lee slopes must be used, select a point where the angle of approach will allow the front bumper to clear.

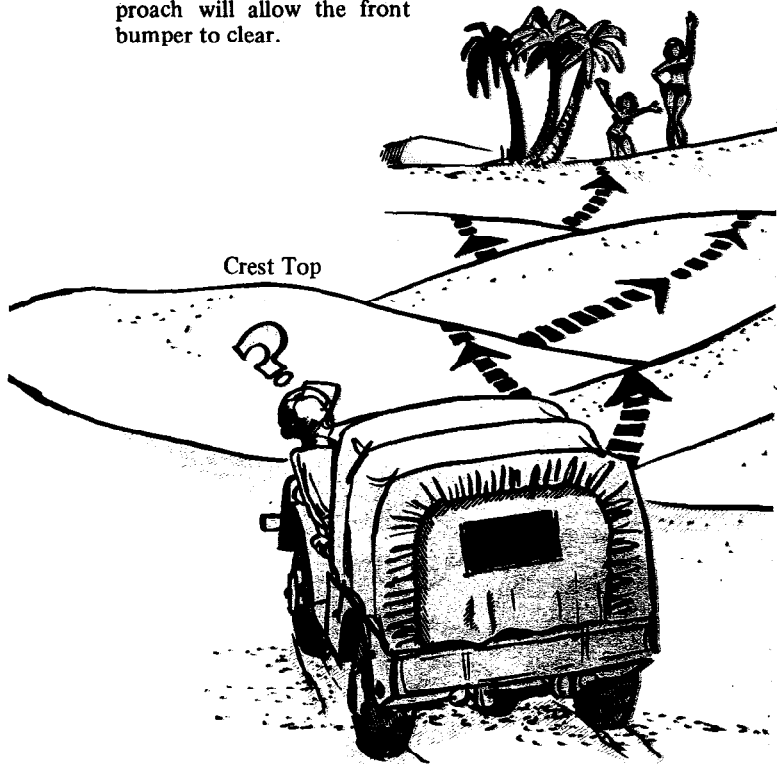

(9) Conditions and feel will indicate whether it is best to follow in the tracks of preceding vehicles or to break a new path.

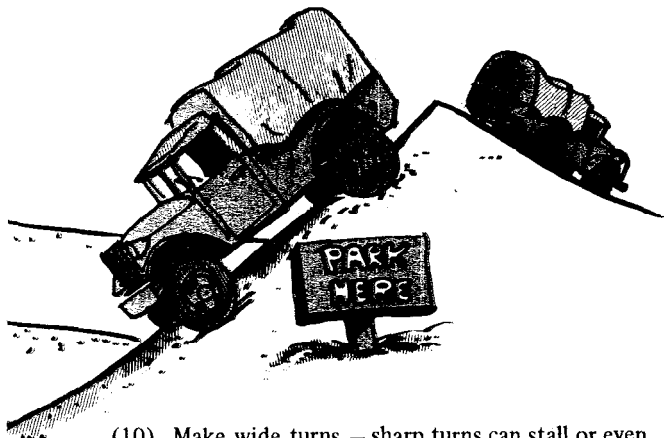

(10) Make wide turns — sharp turns can stall or even overturn your vehicle.

(11) When possible or practical, permit vehicle to roll to a halt. Otherwise, brake gradually; this prevents tires from digging in as happens when brakes are used.

(12) Try to stop on a downhill slope; this will give you an advantage when starting.

(13) At the first sign that your vehicle is bogging down, try a lower gear. If still bogging down, stop power to the driving wheels. Continued attempts at using the engine to force the vehicle out of the sand at this time will only sink it deeper into the sand, making it more difficult to get out. Check tires for sand operation inflation — high temperature may have built up pressure.

(14) If the use of lowered tire pressure alone is not enough to free the vehicle, shovel a clear path ahead of the wheels and lay boards, brush, channels, canvas, wire netting, rope ladders, or some similar material under and in front of the tires to give better flotation and traction.

(15) Use the winch or a tow if it becomes evident that continued operation of the vehicle under its own power will only cause it to sink deeper into the sand.

(16) In the event a vehicle is bellied down and must be pulled out, unload the vehicle to the extent necessary.

f. Recommended Tire Pressures.

(1) Cross-country driving requires a pressure of 45 psi for all tires.

(2) Driving over rocks and boulders requires tires to be correctly inflated to 45 psi, as under-inflated tires will cause internal ruptures of the tire and damage to the tube.

(3) For emergency operations in beach and desert sand, reduce tire inflation to 15 psi.

(4) Vehicle performance in deep mud or snow can be improved by reducing inflation to 15 psi.

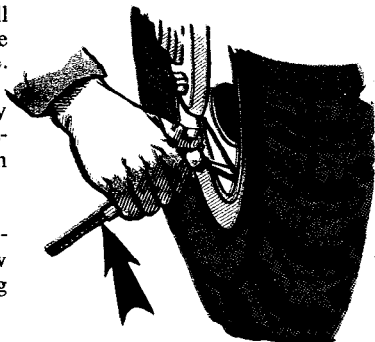

Note. Be sure to restore tire pressure to 45 psi after operating in mud, sand, or snow.

2-29. Fording Operations.

a. General. In fording, your vehicle may be subjected to water varying in depth from only a few inches to depths sufficient to completely submerge it.

Know the DEPTH

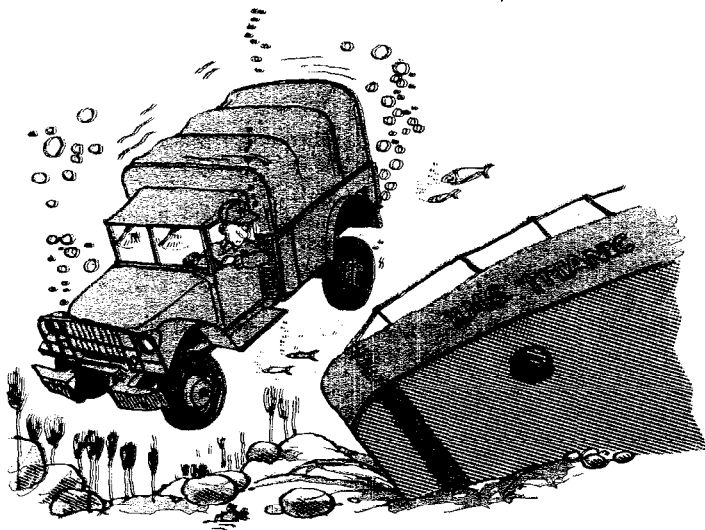

b. Normal Fording. All critical components of your vehicle are provided at manufacture with waterproofing protection for fording bodies of water to a depth of 42 inches. For greater depths, a deepwater fording kit must be installed.

c. Determine the Feasibility of Fording. Verify depth of water to be forded and do not exceed the known fording limits of the vehicle.

d. Observe the following precautions:

(1) Install the fly-wheel housing drain plug stored in the glove compartment.



(2) Make sure the battery cell vent caps are snug.

(3) The engine must be operating at maximum efficiency before attempting to ford.

(4) If the ford is deep enough for the engine fan blades to catch water, loosen fan belt before crossing to avoid throwing water over the electrical system.

(5) Shift transmission into low gear and engage the transfer shift levers in low range and front wheel drive.

(6) Pull out the throttle control to overcome the possibility of a stall when cold water chills the engine, and enter the water slowly.

(7) Should the engine stall while submerged, start in the usual manner.

**enter slowly...
avoid forming
any large
bow wave**

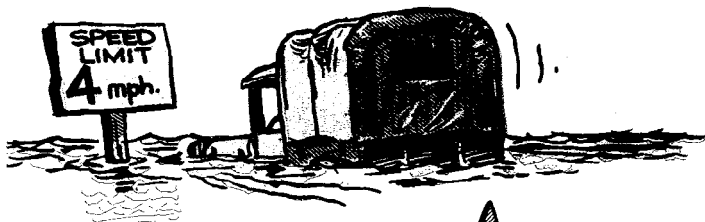

(8) Limit speed to 3-4 mph to avoid forming a bow wave.

(9) Avoid using the clutch, as frequent use while submerged may cause the clutch to slip.

(10) The brakes will usually be lost and may grab after vehicle emerges. Do not rely on brakes until tested and found reliable.

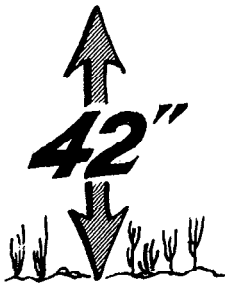

e. Operation after Normal Fording.

(1) After leaving the water, push in the throttle control and disengage front wheel drive if terrain permits.

(2) Apply the brakes a few times to help dry the brake linings.



(3) Open all drain holes in body. Check condition of all tools and equipment. Clean and dry all items and stowage compartments as soon as possible.

(4) Remove flywheel housing drain plug if conditions permit, and stow in glove compartment.

(5) At your earliest opportunity, check the engine oil level and check for presence of water in the crankcase. Heat generated by driving will evaporate or force out most water which has entered at various points, and any small amount of water in the crankcase through leakage or condensation will usually be dissipated by the ventilating system.

(6) All vehicles which have been exposed to some depth of water or completely submerged, especially in salt water, must be presented to organizational maintenance personnel for thorough lubrication and after-fording maintenance services. Precautions should be taken as soon as practicable to halt deterioration and avoid damage before the vehicle is driven extensively in regular service.

f. Deep-Water Fording. Refer to TM 9-238 for general information, kit identification, description, and methods of use of deep-water fording kits, and for general procedures for the operation of vehicles so equipped.

g. Accidental Submersion. If complete submersion of your vehicle occurs accidentally, it must be salvaged and preserved until it can be sent to the support maintenance unit. Notify organizational maintenance.

2-30. Towing the Vehicle.

a. Towing to Start.

(1) The engine may be started by towing the vehicle only after proper approval has been obtained.

CAUTION: Do not attempt to tow the vehicle until the reason for not starting has been determined.

(2) Attach towing cable or chain from pintle of towing vehicle to the lifting shackles on front bumper of stalled vehicle.

(3) Prepare stalled vehicle for towing. Pull out choke control and throttle control about one-third of its travel. Turn ignition switch on. Depress clutch pedal and shift transmission into high (fourth) gear. Make sure transfer lever is in high range and front wheel drive disengaged. Hold clutch pedal down until vehicles are moving at a speed sufficient to start the stalled engine.

(4) Operate the towing vehicle in first gear, starting slowly to avoid unnecessary strain.

(5) As you reach a speed of about 5 mph, carefully release the clutch pedal of the towed vehicle.

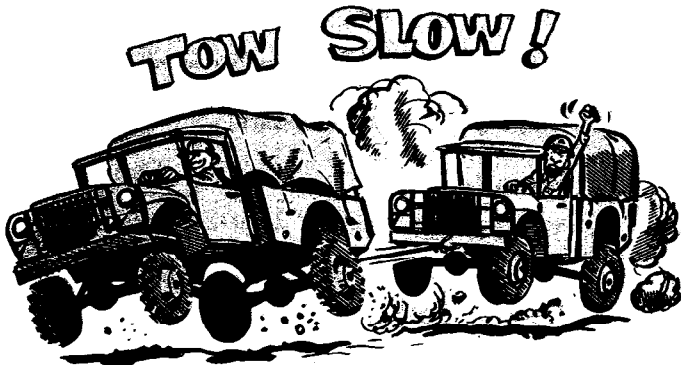

b. Towing Disabled Vehicles.

CAUTION: Do not tow vehicle for more than a 5 mile distance without disconnecting propeller shafts or removing rear axle shafts.

(1) Approval for towing must be obtained from your supervisor. Towing your vehicle when disabled requires varied procedures depending on nature of disability. For this reason, no specific towing procedures are given. However, the instructions below will serve as a guide in selecting the method of towing.

(2) These procedures are for your use only in an emergency. If tactical situation permits, notify organizational maintenance personnel.

(a) If no damage exists in the power train from the wheels through the transfer, the vehicle may be towed with the four wheels on the ground. Disconnect propeller shaft at rear axle ((3) below) or remove rear axle shafts ((4) below). Place transmission in neutral and high range and disengage front wheel drive. This method of towing requires a driver in the towed vehicle to steer and to operate the brakes. Keep towing cable taut by applying brakes as necessary.

(b) If damage is within the transfer assembly, disconnect both axle propeller shafts at the differentials ((3) below) and secure them to the frame. The vehicle may then be towed with all four wheels on the ground ((a) above).

(c) If the damage is within the rear axle, remove the rear axle drive shafts ((4) below). The vehicle may then be towed with all four wheels on the ground ((a) above).

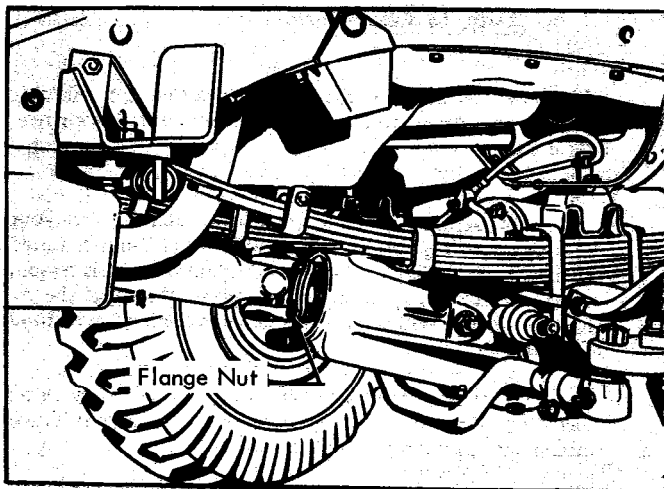

(d) If the damage is within the front axle, or the universal drive parts have been damaged, remove the front axle drive flanges (5) below) and disconnect propeller shaft at rear axle. The vehicle may then be towed with all four wheels on the ground (a) above).

(e) If the vehicle must be towed with the front wheels off the ground, make certain front wheel drive is disengaged. Disconnect propeller shaft at rear axle (3) below) or remove rear axle drive shafts (4) below).

(f) Avoid towing the vehicle with the rear wheels off the ground, unless other methods are impossible.

CAUTION: In all situations under which a disabled vehicle is to be towed, be sure to place transmission in neutral and high range and disengage front wheel drive.

(3) Use the following procedure for disconnecting propeller shaft:

(a) Procedure is the same for all propeller shafts.

(b) Remove the four nuts, lockwashers, and bolts that secure each universal joint flange yoke to the companion flange on the differential and secure propeller shaft to frame.

(c) If necessary, disconnect at transfer and remove shaft.

(4) Rear axle drive shaft removal:

(a) Both drive shafts are removed in the same manner. It is not necessary to raise the rear axle.

(b) Remove nuts and lockwashers from the six drive shaft flange studs.

CAUTION: Be careful. Residual torque.

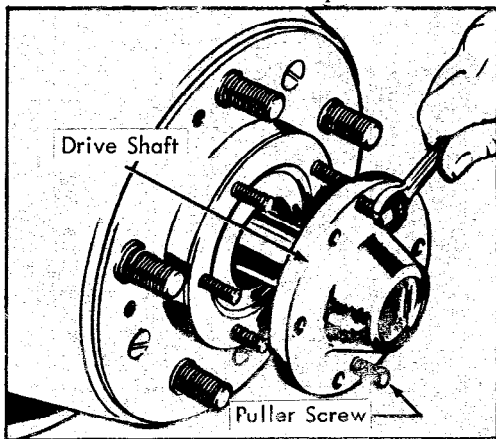

(c) Remove the two puller screws from the flange and remove nuts. Reinstall puller screws in the flange and tighten evenly to force flange from the hub. Pull the drive shaft from axle housing.

(d) Secure a piece of tin or cardboard over the flange openings to retain grease in the axle and prevent entrance of dirt.

(5) Front and rear axle drive flange removal:

(a) Remove nuts and lockwashers from drive flange studs.

(b) Remove the two puller screws from flange and remove nuts.

(c) Reinstall puller screws in flange and tighten evenly to force flange from the hub.

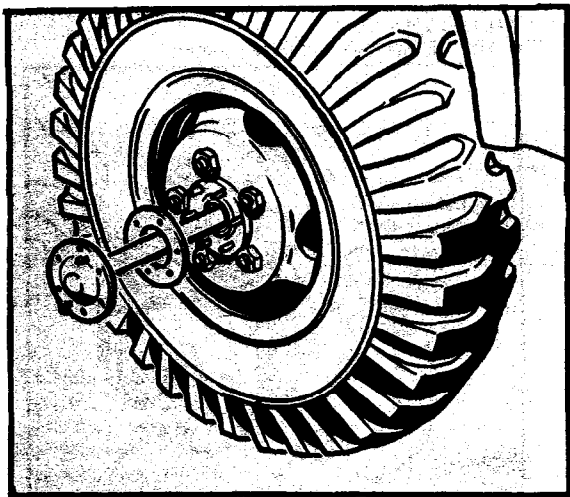

2-31. Vehicle Recovery and Field Expedients.

a. Mechanical Advantage.

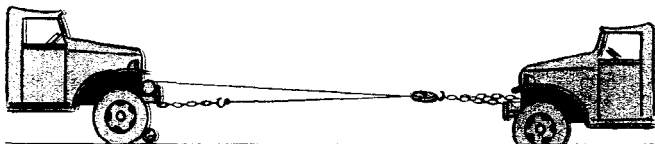

(1) Two-Part Line. This simple hookup gives you a 2:1 mechanical advantage. Attach a snatch block to the load. Next, run your winch cable through the block and secure the cable on the winch vehicle.

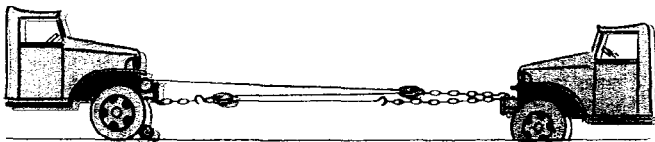

(2) Three-Part Line. To get a mechanical advantage of 3:1, use two snatch blocks – one at the load and one on the winch vehicle. Your winch cable goes first through the block on the load, then back through the block on the winch vehicle, and then again to the load where it is secured.

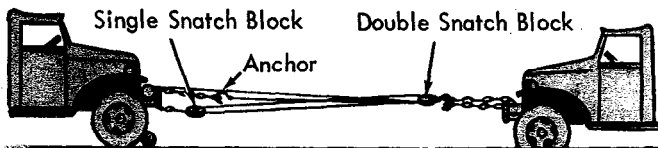

(3) Four-Part Line. You can get a 4:1 mechanical advantage by using two blocks, a double sheave block for the load and a single sheave snatch block for the winch vehicle. The winch cable goes through one sheave of the double block attached to the load, back through the single sheave on the winch vehicle, again to the load through the second sheave of the double block, and is finally secured to the winch vehicle.

b. Vehicle Recovery. The text that follows describes a few of the more common field recovery operations you can perform with limited resources. In all of these operations, you must use ingenuity to make up for a lack of available horsepower. Take your time in figuring your rigging and include a reasonable factor for safety. Sloppy planning results in wasted time and may cause further damage to your vehicle and equipment and injury to yourself and others. Recovery failures are often the direct result of too much hurry.

(1) Natural anchors. Trees, stumps, or rocks are natural anchors. Always attach your lines near the ground when using a tree or a stump as an anchor. It is also advisable to lash the first tree or stump to a second one to provide added support for the line. When using a rock as an anchor, be sure it is large and firmly imbedded in the ground.

(2) Constructed anchors. Anchors are constructed when natural ones are not available. The deadman is one of the best types of constructed anchors and can be used for heavy loads. It consists of a log, timber, steel beam, or other similar object buried in the ground with a deadline connected to it at the center. To construct a deadman, the following procedure is used:

(a) Select a place where the direction of pull is as nearly horizontal as possible, such as a sharp bank or crest. You can obtain more holding power with less digging.

(b) When digging, slant the bank at least 15 degrees from the vertical and undercut toward the disabled vehicle.

(c) Drive stakes in front of the deadman at each end to hold it in place.

(d) Tie the deadline to the center of the deadman so the main or standing part of the line leads from the bottom of the deadman. Dig a narrow trench for the deadline to the center of the deadman. If the deadline has a tendency to cut into the ground, place a log or plank under the line at the outlet from the inclined trench.

(e) Tie deadline to center of deadman so that the main part of the line leads to the bottom. This will prevent the deadman from rotating out of the hole.

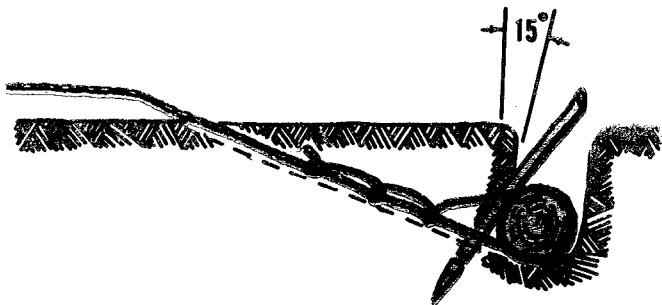

(3) Winch recovery. If your vehicle is equipped with a winch, you should know how to get the most out of it without danger to personnel or abuse of the equipment. To insure your safety, the protection of your equipment, and the success of your recovery operation, the following checklist may be used as a guide.

(a) Check the capacity of your winch. The capacity shown on the manufacturer's plate is the maximum with one layer of cable on the drum. Each successive layer increases the diameter of the drum and reduces the winch capacity to as little as 50 percent of the rated capacity when the last layer is being wound on the drum.

(b) Check the cable for rust, kinks, or frays.

(c) Estimate the total resistance. Consider grade or slope, weight of the vehicle, and type of terrain; then add a reasonable factor of safety.

(d) Check your equipment. Make certain that you can rig safely to overcome the resistance with the equipment available.

(e) Select, or provide, a suitable anchor. Remember that the object of this operation is to recover a vehicle, not to pull stumps.

(f) Rig – and check rigging. Don't put power on your winch until you have checked every element in your rigging and are satisfied that you have made no mistakes.

CAUTION: Clear personnel from danger area. All persons observing the operation should stand outside the angle formed by the cable under stress and at a distance at least equal to the distance between the two most distant points in the rigging. Clear personnel away before the cable is tightened.

(4) Single vehicle operations.

(a) When you have been individually dispatched and get into a spot where your traction is not enough to get you through, you can use your winch and suitable rigging to pull you through or to get you back to solid footing. Working alone, or with your crew, recovery may take time but don't skimp on planning. Your training should keep you out of the really bad spots and, if you don't lose your head, you should be able to get through with a little extra effort intelligently applied.

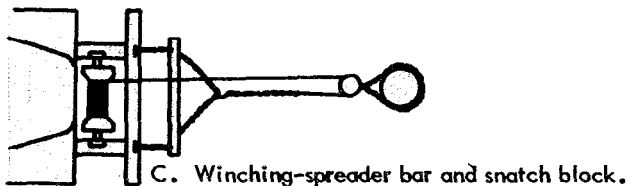
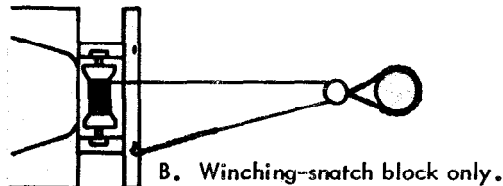
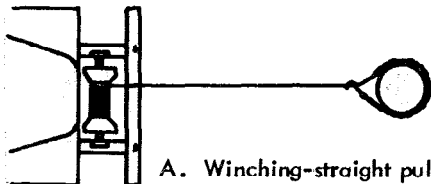

(b) Select or construct a strong anchor. Attach a snatch block to the anchor with your towchain, and run the winch cable through the block and back to the truck. Take up the slack gradually and pull the truck forward with its winch. Power may be applied to the wheels at the same time.

(5) Winching safety. Recovery operations take time. Don't hurry. A broken winch line will react like a sling shot and can throw a 200-pound object a distance of 300 yards. When hooking to a vehicle, use both shackles whenever possible so that effort is applied equally and damage to the vehicle is minimized. Use a sling for this purpose; a chain makes a good sling.

**WHEN WINDING CABLE
BACK ON THE WINCH...
GET HELP
TO REEL IT EVENLY**

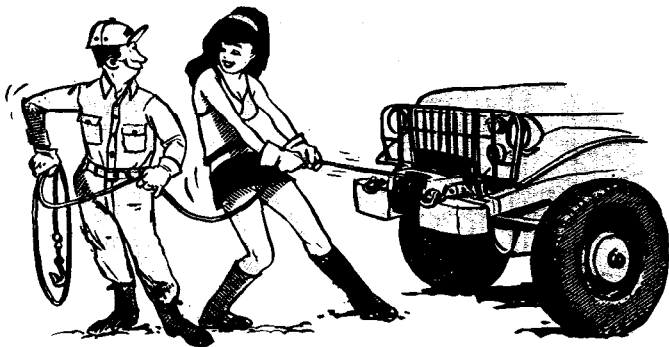

(a) Never bend the wire cable at a sharp angle. Straighten out all kinks and twists as you take up the slack. Do not permit tractors or vehicles with metal tracks to run over the cable. Such abuse flattens the cable, exposes the manila hemp core, and permits water to enter, causing internal rust and weakening of the cable.

(b) Stand clear of a winch cable before it is tightened. A cable being tightened may break and whip back with force enough to kill or seriously maim.

(c) After using the winch, have one person, or preferably two, pull back on the cable while it is wound slowly and evenly on the drum. Stow the chain by passing it under and over left frame member, across front of winch, and hook over right gusset. Operate the winch slowly until the chain is taut. Stop the winch and secure it.

(d) Keep the cable lubricated in accordance with lubrication order LO 9-2320-212-12.

(6) Replacing broken winch shearpin.

Note. Notify organizational maintenance personnel if shearpin breaks. If tactical situation requires it, the following emergency procedure may be used.

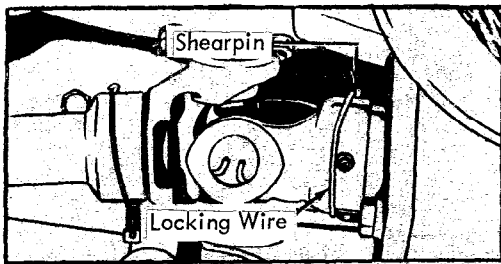

(a) General. When the winch is overloaded, the shearpin breaks to protect the cable. Never use makeshift shearpins of unknown strength to replace a broken pin; too strong a pin may cause the cable to snap and damage the winch. Use only authorized replacement pins. Don't depend on the shearpin for protection. Even with the proper pin installed, a kinked, damaged, or weakened cable may snap.

(b) Preparation. Since breakage of the shearpin usually occurs as a result of overloading the winch, it is important that the winch load be lessened before attempting to move or support it after replacing the shearpin.

(c) Replacement. Remove locking wire from drive shaft shearpin and remove broken pieces. Position universal joint front yoke on wormshaft, aligning shearpin holes. Install new shearpin and locking wire or cotter pins.



CAUTION: Support load or make certain that safety brake will hold winch load while replacing shearpin.

(7) Manpower recovery. Recovery operations in which you are limited to manpower and material at hand can be successful if you have enough time.

(a) Use of the pry, or lever, in lifting. If your vehicle has dropped into a hole or ditch, manpower can get you out. First, find a length of timber or similar material, approximately 8 feet in length and with a diameter that will permit it to be handled by personnel available. Place a suitable support near the point of lift - a log or rock that won't be disturbed when the pressure is applied. Rig the lever under the bumper for the first lift. Block when you have gained all you can. Rerig for a second lift with the point of the lever under the axle if possible; lift and block. Repeat this performance until the vehicle can be backed off without too much trouble.



(b) Use of the lever to move a vehicle. When you are alone and have to move a light vehicle a short distance without power, you can make use of the lever. A fairly long pole, or crowbar; a rope, cable, or chain; and a suitable anchorage for the point of the bar, are the materials you will need. The distance from the lever to the point of attachment of the tow rope must be quite small to give you enough advantage. You won't get very far at each bite, but you will be able to move slowly.

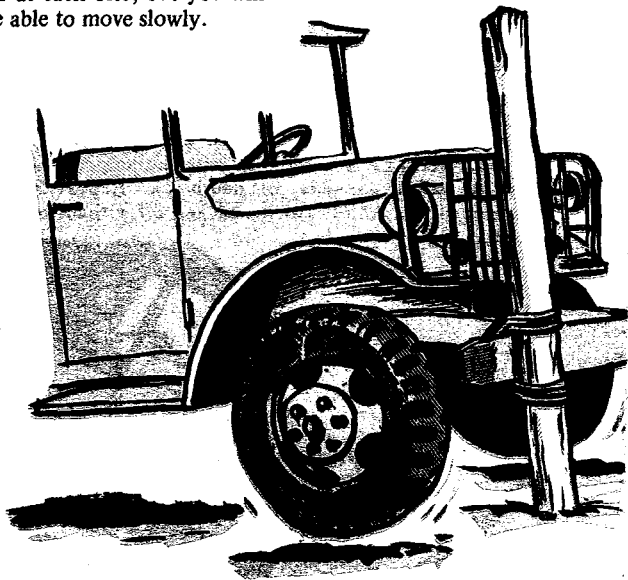

(8) Using the A-frame. Narrow ditches, slit trenches, and shell holes can quickly stop your truck. They are com-

mon obstacles to off-road movement and may be hard to see. If your front wheels should drop into one, you will find the A-frame a very useful recovery tool. It is neither too difficult to put together nor too complicated to use. You will need two poles approximately 8 feet long and large enough in diameter to support the front end of your truck. Lash them together near the top by a figure-8 or girth knot using your towchain or a length of rope. Dig two holes 10 to 12 inches deep and 5 or 6 feet apart to hold the legs in position when power is applied. Rest the upper end of the A-frame on the hood of the truck with the legs in the anchor holes. Select a suitable anchor in front of the truck and tie a line from the A-frame joint to the anchor, bringing the frame up to a position where the frame joint is directly over or slightly to the rear of the bumper. Rig your winch line through a snatch block fastened to the A-frame joint and secure it to the front bumper. Winch up the front end of the truck until the wheels clear the ditch, then slowly back the vehicle off to solid ground. When you are safely away from the edge of the ditch, you may lower the wheels and unhitch your rig. If you have no winch, another vehicle may be used for power, though more rigging will be required.

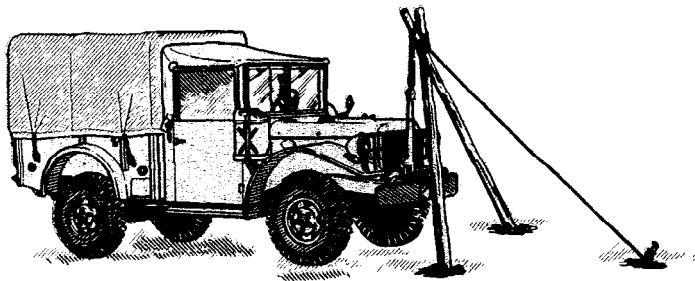

c. Field Expedients During Emergency.

(1) General. Field expedients can be considered as those one-time emergency operations or procedures that you may use to get out of a tight spot during tactical operations. Expedients should be resorted to only under unusual or emergency conditions. The equipment is usually prepared as needed from materials at hand, most of which have been designed or intended to serve another purpose. Tire chains used as towchains, for instance, may be considered as a field expedient. A truck tarpaulin used to wrap a ¼-ton truck to float it across a river would be another example. The list of field expedients that have been used successfully is long. It is beyond the scope of this text to describe all of them. The few described below will give some idea of the possibilities.

(2) Substitutes for a jack.

(a) A practical substitute for a jack, good for any wheel on an all-wheel drive vehicle, is to rig an inclined plane with two logs of suitable size — or a stone and a log. By driving the vehicle ahead, the axle is pushed up the log until the wheel clears the ground. Set brakes and block vehicle securely. You can easily back off when your job is completed.

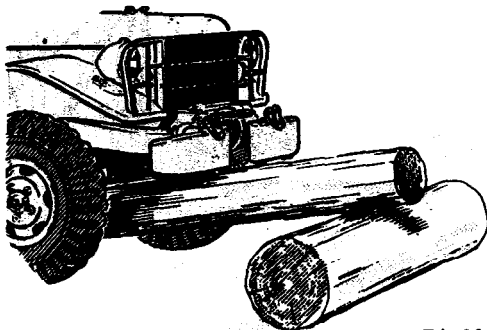

(b) You can make your own bumper jack to raise the front end by fastening a piece of timber about 5 feet long at an angle to the front bumper with a chain or rope. Move your vehicle forward until the timber is vertical and the wheel clears the ground. Set brakes and block the vehicle securely before going to work on the tire. When through, back off and unhitch.

(3) To raise a wheel. When one of your driving wheels falls in a deep hole, you can get out with a log and a chain. Chain the log to the wheel and move forward slowly to prevent spinning. If the wheel spins, the log will damage the fender or other parts of your vehicle. After clearing the hole, force the log under the wheel to prevent falling back into the hole.



(4) Skid. A flat tire or bad wheel, either of which you are unable to repair, should not stop your four-wheel drive (4 x 4) vehicle. You can use a skid on the rear wheels only. If necessary, change wheels from one hub to another. A skid is used in the following manner:

(a) Obtain a pole approximately 4 inches in diameter and 6 to 8 feet long.

(b) Place one end above the cross-member near the transmission and the other end on the ground.

(c) Pass the pole under the spring U-bolts, align it with the spring, and lash it securely to the spring.

(d) Using front wheel drive, move the vehicle. Starting will be difficult, but once moving it will ride and handle surprisingly well.

(5) Tire chain substitutes. Rope or towchains can be wrapped around the wheels as tire chain substitutes. Be sure to fasten them securely but leave slack around the tires to prevent damage. Remember that these are only temporary substitutes and must be removed as soon as possible.

(6) Engine failures during field driving. Engine failures are commonly caused in the field by either fuel or ignition troubles. You will be able to correct some of these by field expedients, though you must remember that these are only field expedients – not repairs. Your unit maintenance personnel should be informed as soon as possible so that proper repair may be made, if necessary. A few of these field expedients are described below.

(a) Shorted distributor cap. A cracked distributor cap will cause your engine to miss and backfire, particularly in damp weather when the crack is filled with moisture. To correct this, carefully clean and dry the distributor cap, scrape the crack or runner and fill the crack with tar from the top of your storage battery.

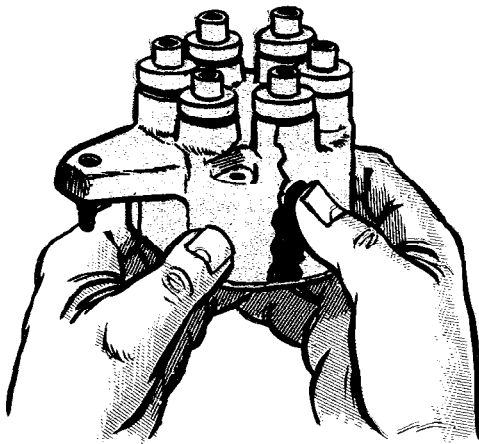

(b) Broken distributor point spring. If your engine cuts out, stops, and cannot be restarted, the cause may be a broken distributor point spring. Take off the distributor cap and, if this is the cause, cut a piece of rubber from a tire and double it behind the spring. The engine will then start and will operate at slow speeds. The rubber substitute cannot close the points fast enough for high speed operation.

(c) Frozen fuel lines. Condensation in your fuel tank may get into your fuel lines and freeze in cold weather, effectively cutting off the supply to your carburetor. You can thaw out these spots by using hot water. Never use a flame directly on the line, or any device that could cause a spark.

(d) Leaking line fitting. Leaks at fuel line fittings can develop from the vibrations caused by cross-country operation and may result in an extremely dangerous condition if not discovered and corrected promptly. To correct this deficiency, unscrew the coupling nut, wind a piece a string clockwise behind the flare, slide the coupling nut over this temporary gasket, and tighten with a wrench.

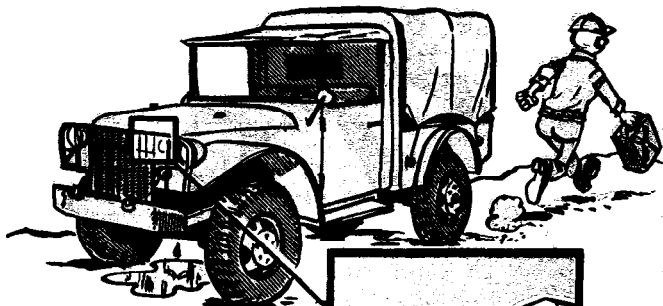

**LOCATE
YOUR PROBLEM
FIRST**



(e) Fuel pump vapor lock. This failure is caused by high temperatures vaporizing gasoline in the fuel line. The fuel pump will not pump vapor. Cooling of the fuel pump and condensation of the vapor can be effected by soaking a cloth in water and placing it over the fuel pump. The evaporation of moisture from the cloth has a refrigerating action which is most effective in hot, dry climates.

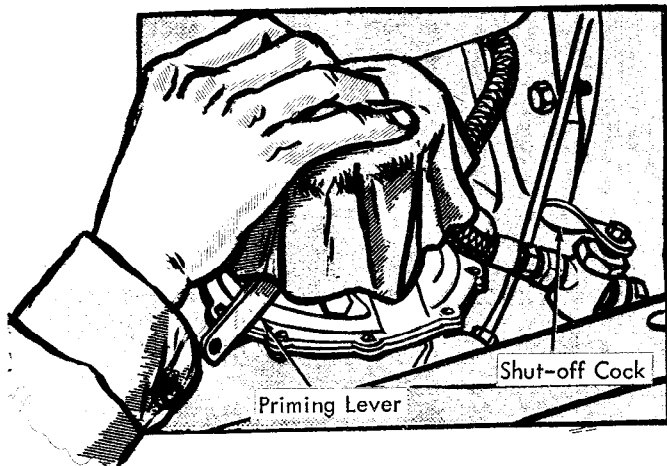

(f) Other. Two other common occurrences that can cause damage to your engine are a punctured radiator and a broken fan belt.

1. Punctured radiator. Cut the cooling fins and push them back from the tubes in front of the leaky tubes. This will give you enough room to work. Cut the leaking tube in half and fold the ends back about three-quarters of an inch. Close the ends by pressing them flat with pliers. This repair may hold permanently but radiator efficiency is reduced when several tubes are cut and engine may overheat.



2. Broken fan belt. Faulty fan belts should be found and replaced during your daily maintenance service and inspection. However, if the fan belt breaks and no replacement is available, a fiber rope from the vehicle tarpaulin or a piece of field telephone wire may be used. Loop the rope around the pulley three or four times and tie with a square knot.

CHAPTER 3

MAINTENANCE INSTRUCTIONS

Section I - LUBRICATION

3-1. Lubrication Instructions.

a. Cleaning and lubricating procedures as to locations, intervals, and proper materials for this vehicle which are your responsibility as an operator are prescribed in the Lubrication Instructions illustration on the next two pages.

b. Specific lubrication procedures required for particular mechanisms are given in their pertinent sections.

c. For complete lubrication instructions, refer to lubrication order LO 9-2320-212-12.

3-2. Service Intervals.

Service intervals specified are for normal operation and where moderate temperature, humidity and atmospheric conditions prevail. Report unsatisfactory performance of prescribed petroleum fuels, lubricants, or preserving materials, using DA Form 2407, Maintenance Request.



LUBRICANT • INTERVAL

Winch Worm Case Level
(Check level) W

Winch Worm Case Fill GO

Crankcase Fill OE

Crankcase Level
(Check Level) D

Transmission
Fill and Level
(Check level) GO - W

INTERVAL • LUBRICANT

Winch Cable OE

Winch Drum and
Shaft Case Level
(Check level) W

Winch Drum and
Shaft Case Fill W - GO

Front Differential
Fill and Level
(Check level) W - GO

Air Cleaner
(Check level) M - OE

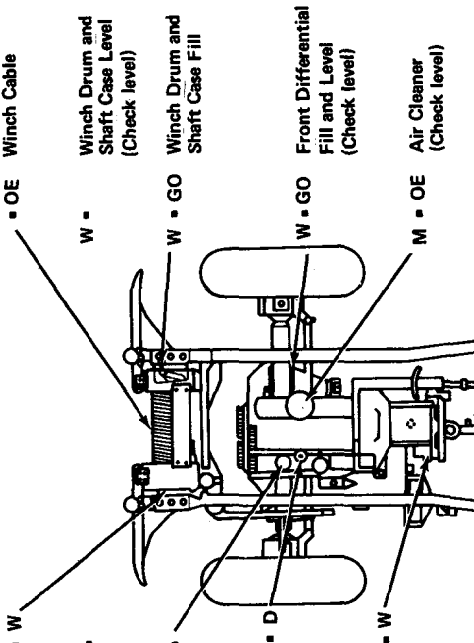

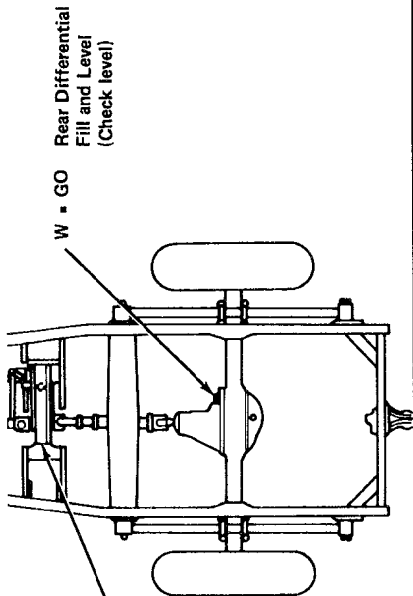

Transfer Case
Fill and Level
(Check level)

GO = W

W = GO
Rear Differential
Fill and Level
(Check level)

— KEY —

LUBRICANTS	EXPECTED TEMPERATURES			INTERVALS
	above +32° F	+40° F to -10° F	0° F to -65° F	
OE/HDO Oil, Lubr, Engine	OE/HDO 30	OE/HDO 10	OES	Refer to TM 9-207 For Arctic Operation
GO-Lubricant, Gear, universal	GO 90	GO 75	GOS	
PL-Oil, lubr, preservative	PL (Med)	PL (Special)	PL (Special)	
				OES-Oil, lubr, engine, sub-zero GOS-Lubricant, gear, universal, sub-zero CW-Lubricant, chain, exposed gear and wire rope
				D - Daily W - Weekly

Lubrication Instructions

**Section II - PREVENTIVE MAINTENANCE
CHECKS AND SERVICES**

3-3. General.

a. Scope. Preventive maintenance is performed by the vehicle operator. As operator, your responsibilities are:

(1) To perform the daily service each day the equipment is operated.

(2) To assist the organizational maintenance mechanics in the performance of scheduled periodic services.

(3) To assist the organizational maintenance mechanics in the lubrication of the equipment in accordance with the pertinent lubrication order.

b. Recording Repairs. Deficiencies discovered before, during, and after operation that you cannot correct will be entered on DA Form 2404.

c. Intervals. The vehicle's semi-annual "S" service is performed at 6,000 miles or six-month intervals, whichever occurs first.

Note. Lubrication intervals should be shortened and lubrication frequency increased when operating under unusual conditions such as extreme temperatures, dust or sand, or extremely wet terrain. Prescribed frequency of preventive maintenance services is considered a minimum requirement for normal operations.

d. Unwashed Vehicles. You should present the vehicle for a scheduled preventive-maintenance service in a reasonably clean condition; that is, it should be dry and not caked with mud to such an extent as to seriously hamper inspection and services. However, washing of the vehicle should be avoided immediately prior to an inspection, since certain types of defects such as loose parts and leaks may not be evident immediately after washing.



3-4. Procedures.

a. The following general procedures apply to preventive maintenance services and to all inspection, and are just as important as the specific procedures.

b. Inspections to see if items are in good condition, correctly assembled or stowed, secure, not excessively worn, not leaking, and adequately lubricated apply to most items in the preventive maintenance and inspection procedures.

c. Inspection for good condition is a visual inspection to determine whether the unit is damaged beyond safe or serviceable limits.

d. Inspection of a unit to see that it is correctly assembled or stowed is a visual inspection to see if the unit is in its normal position in the vehicle and all its components present.

e. Inspection of a unit to determine if it is secure is a visual examination or a check for looseness.

f. By "excessively worn" is meant worn beyond serviceable limits or to a point likely to result in failure if the unit is not replaced before the next scheduled inspection.

g. Where the instruction "tighten" appears, it means tighten with a wrench, even if the item appears to be secure.

h. It is understood that whenever inspection reveals the need for adjustment, repairs or replacement, the necessary action will be taken.

3-5. Cleaning Instructions.

a. Use dry-cleaning solvent or mineral spirits paint thinner to clean or wash grease or oil from all parts of the vehicle.

b. A solution of one part grease-cleaning compound to four parts of dry-cleaning solvent or mineral spirits paint thinner may be used for dissolving grease and oil from engine block, chassis, and other parts. Use cold water to rinse off any solution which remains after cleaning.

c. After the parts are cleaned, rinse and dry them thoroughly. Apply a light grade of oil to all polished metal surfaces to prevent rusting.

d. To prevent formation of damaging mildew, shake out and air the canvas cover for several hours at frequent intervals. Have any loose grommets or rips in the canvas repaired. Mildewed canvas is best cleaned by scrubbing with a dry brush. If mildew is present, examine fabric carefully for evidence of rotting or weakening. Oil and grease can be removed by scrubbing with issued soap and warm water. Rinse well with clear water and dry.



3-6. Cleaning Precautions.

WARNING: Dry-cleaning solvent or mineral spirits paint thinner is flammable and should not be used near an open flame. Use only in well-ventilated places. Fire extinguishers should be available during use.

a. These cleaners evaporate quickly and have a drying effect on the skin. Used without gloves, they may cause irritation, inflammation or cracking of the skin.

b. The use of diesel fuel oil, gasoline, or benzene (benzol) for cleaning is prohibited.

CAUTION: Avoid getting petroleum products such as dry-cleaning solvent, volatile mineral spirits, engine fuels, or lubricants on rubber parts, as they will deteriorate the rubber.

3-7. Preventive Maintenance.

a. **Purpose.** To assure maximum operational readiness, it is necessary that you systematically inspect your vehicle at intervals every day it is operated.

b. Daily Preventive Maintenance Service. You should be so thoroughly familiar with these procedures that you apply them as a matter of course to your vehicle every day. PMCS consists of three responsibilities:

(1) Before-Operation Service. This is a brief service to ascertain that the vehicle is ready for operation.

(2) During-Operation Service. This service consists of detecting unsatisfactory performance. While driving, you should be alert for any unusual noises or odors, abnormal instrument readings, steering irregularities, or any other indications of malfunction of the vehicle.

CHECK YOUR LIGHTS

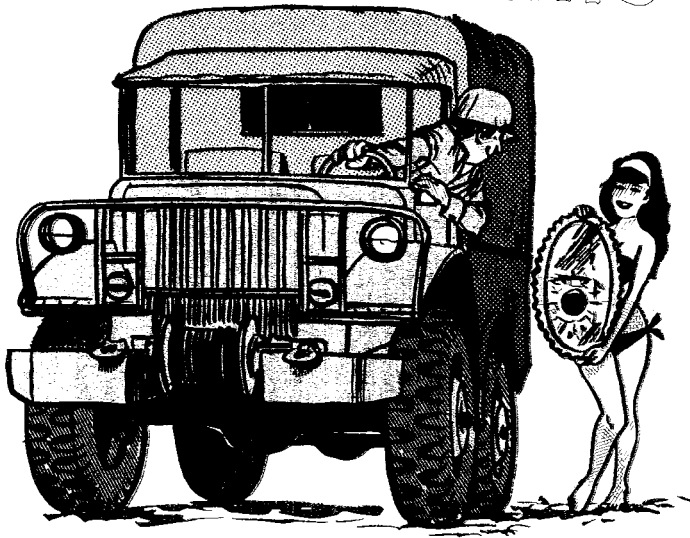

(3) After-Operation Service. This is the basic daily service for tactical vehicles. It consists of correcting, so far as possible, any operating deficiencies.

c. Follow the procedures listed in the table on pages 3-10 to 3-16, preventive-maintenance checks and services, in the numerical order given.

Note. Any defect or unsatisfactory operating characteristics beyond your scope to correct must be reported at the earliest opportunity to your supervisor.

Preventive Maintenance Checks and Services

B - Before Operation		D - During Operation	A - After Operation
Interval and Sequence No.		Item to be inspected	
B	D	A	Procedure
1			<p>WARNING: Never leave hood open unless secured by hood holder. A gust of wind or sudden jar may cause hood to fall, resulting in serious or fatal injury.</p> <p>RADIATOR COOLANT</p> <p>Check coolant level. Fill to 2-1/4 inches below filler neck top. Check if drain cocks are tight. Inspect hoses and radiator core for leaks.</p>
2			<p>ENGINE OIL LEVEL</p> <p>Check oil level, and add as required. Do not exceed FULL mark. (See para. 3-15 for safe operating range.)</p>
3			<p>CARBURETOR AIR CLEANER</p> <p>Check oil bath air cleaner. Replenish to bead level, or clean and refill as required by operating conditions.</p>

4	ENGINE COMPARTMENT Inspect for fuel, oil, and water leaks. Look under vehicle for leaking gear oil or brake fluid.	
5	TIRES AND WHEELS Gage tires for correct pressure, including spare. Remove penetrating objects such as nails or glass. Note if tire loses air. Note unusual wear or missing valve caps. Check spare wheel stowage. Inspect wheel and drive flange stud nuts for tightness. NOTE: Inflate tires to 40 PSI for highway and cross-country driving, and 15 PSI for mud, sand, or snow operations. Do not gage tires when they are hot.	21
*6	BATTERIES AND WIRING Remove battery filler caps and check electrolyte level. Fill as required. If distilled water is not available, clean drinking water may be used. Inspect terminals and clean as required. See that all wiring is properly secured and connected.	
7	FIRE EXTINGUISHER See that fire extinguisher is charged and sealed (on vehicles so equipped). * Operations on batteries to be performed weekly.	

Preventive Maintenance Checks and Services - Continued

B - Before Operation		D - During Operation	A - After Operation
Interval and Sequence No.		Item to be inspected	
B	D	A	Procedure
8			<p>TOOLS AND PUBLICATIONS</p> <p>Check all vehicle and pioneer tools for serviceability and proper stowage. See that lubrication order, vehicle manual, and equipment log binder and forms are in order. See that clutch housing drain plug is in glove compartment.</p>
9		22	<p>VEHICLE EQUIPMENT</p> <p>Inspect for security of mounting or damage: cab and body, windshield clamps and catches, doors, windows, winch, lifting shackles and pintle. Generally inspect body panels, fasteners, locks and latches, tailgate, chains, stakes, bows, canvas covers and curtains, safety straps, and lashings. Note paint condition and legibility of markings and identification and caution plates. Inspect ambulance litter racks and maintenance truck racks, reel, and clamps.</p>
10		18	<p>LIGHTS, HORN, HEATER</p> <p>If tactical situation permits, operate horn and windshield wipers. Inspect rear view mirrors. Check all lights and switches (if tactical situation per-</p>

11	19	mits). Note condition of all lights and reflectors. Test ambulance surgical light, dome light, blowers, and heater.
		BRAKES
		Before operation, check brake pedal for correct travel. Free brake pedal should not be less than 1/4 in., no more than 3/8 in. Check stoplight. Check handbrake operation. While driving, note braking effectiveness.
12		STARTER
		Check starter pedal for normal actuating pressure, and note whether engine starts promptly without unusual noises.
		CAUTION: If no oil pressure is indicated within 10 seconds after engine starts, stop engine and determine cause.
13	20	ENGINE
		Observe instruments for normal readings during warm-up and while driving. Note that choke and throttle controls function satisfactorily. Note that engine idles properly. Listen for any unusual noises at idle and higher speeds. While driving, note that vehicle has normal power and acceleration in each speed range. Listen for any unusual noises while engine is under load. Be alert for improper functioning of steering, clutch, or brakes. Note any operating faults such as wander, shimmy, difficulty in engaging gears, etc. Under favorable conditions, on a level stretch of unobstructed highway, accelerate to see that vehicle reaches - but does not exceed - maximum permissible speed.

Preventive Maintenance Checks and Services - Continued

		B - Before Operation	D - During Operation	A - After Operation
Interval and Sequence No.	Item to be inspected	Procedure		
		B	D	A
14	EXHAUST During engine warm-up, listen for excessive or unusual noise, and inspect for exhaust leaks. WARNING: Correct exhaust leaks as soon as possible to prevent possible illness from exhaust fumes.			
23	BRAKE DRUMS AND POWER TRAIN Immediately after operation, feel all units cautiously. WARNING: Full floating hypoid axles operate quite hot. If lubricant levels are correct and no unusual noises were heard during operation, assume axles are functioning properly. Do not touch hypoid axles with bare hand after vehicle has been driven a considerable distance, as serious burns may result.			

23 BRAKE DRUMS AND POWER TRAIN - Continued

An overheated wheel hub and brake drum indicate an improperly adjusted, defective, or dry wheel bearing, or a dragging brake. An abnormally cool condition indicates an inoperative brake. An overheated gear case indicates lack of lubrication, adjustment or defective parts.

24 RADIATOR AND CAP

Inspect radiator core for clogging by foreign matter or for damaged fins. Check pressure cap gasket. Note coolant level and examine for contamination. In cold weather, test with hydrometer to determine proper anti-freeze solution.

WARNING: If necessary to add coolant to radiator while engine is overheated, idle engine and add coolant slowly. Use extreme care in removing pressure cap, as serious burns may result.

25 WINCH CABLE

Clean and oil winch cable in accordance with current lubrication order.

LUBRICATION

Lubricate daily or weekly those items specified on lubrication order. Check gear cases and replenish to proper levels as required. Leaks will not exceed 3 drops in 5 minute period.

Preventive Maintenance Checks and Services - Continued

B - Before Operation D - During Operation A - After Operation

Interval and Sequence No.	Item to be inspected	
	B	A
16		<p>FUEL</p> <p>Refuel vehicle and fill spare gasoline can as required.</p> <p>CAUTION: When filling tank, always hold pump hose nozzle firmly against strainer tube to prevent static sparks. Do not fill upper filler pipe, as room must be provided for expansion of fuel.</p> <p>Clean strainer in tank filler neck.</p> <p>WARNING: Always remove strainer to check, unless checking in daylight. Do not use any light to inspect strainer while installed in tank.</p>
17		<p>CLEAN</p> <p>Clean inside of cab and body, and all glass and mirrors. Clean engine and engine compartment as required. Remove any accumulation of mud, brush or debris from under vehicle. Inspect springs, shock absorbers, and steering tie rods and drag links for damage or looseness. Wipe dust from exterior with clean soft cloth, or wash as required.</p> <p>NOTE. Investigate and correct operating deficiencies as they occur. If beyond your scope, report them to your supervisor immediately, and record on DA Form 2404.</p>



Preventive Maintenance Locator

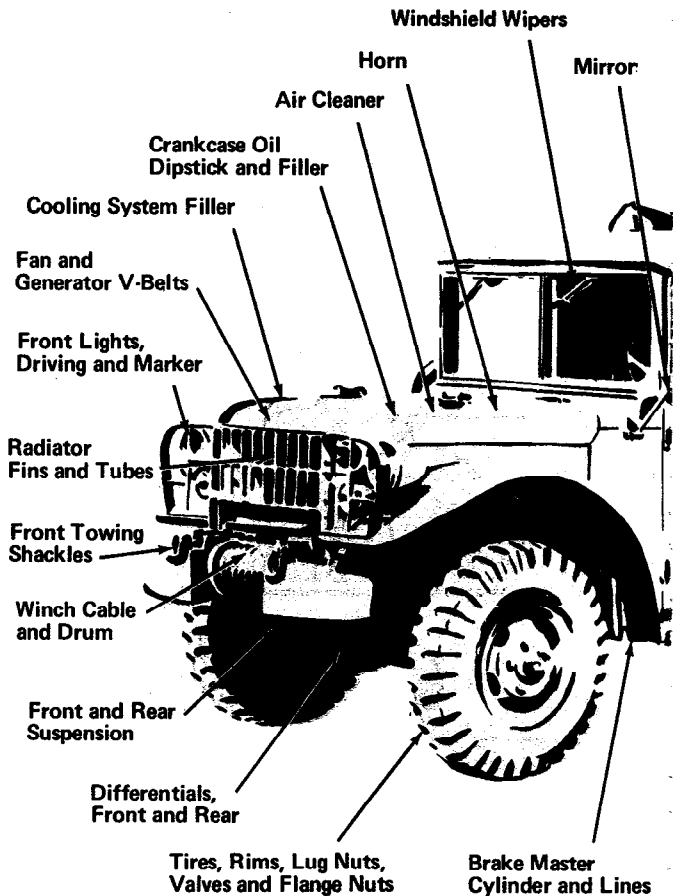

Tools and Publications

Transmission and Transfer Oil Level

Fuel Tank and Filler Cap

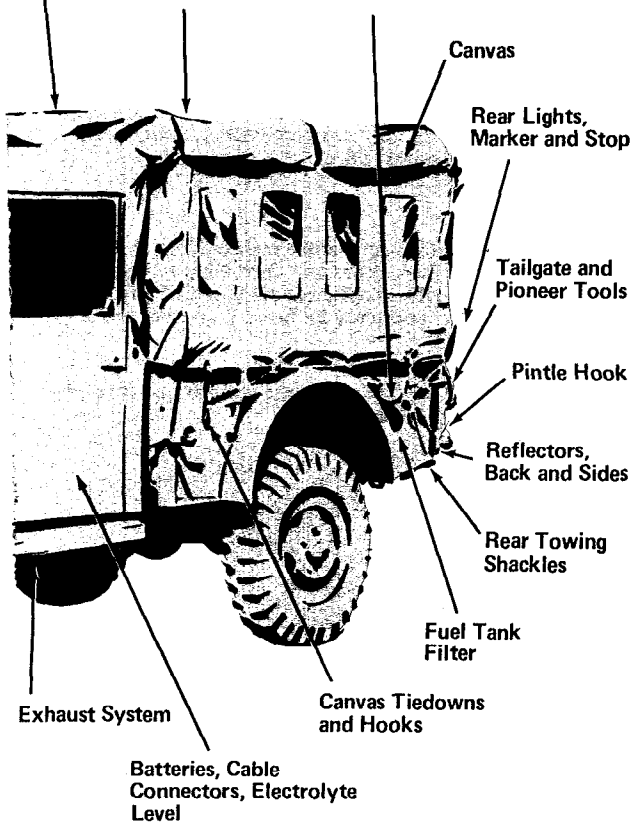

Canvas

Rear Lights, Marker and Stop

Tailgate and Pioneer Tools

Pintle Hook

Reflectors, Back and Sides

Rear Towing Shackles

Fuel Tank Filter

Canvas Tiedowns and Hooks

Exhaust System

Batteries, Cable Connectors, Electrolyte Level

Section III - TROUBLESHOOTING

3-8. General.

This section contains troubleshooting information for locating and correcting most of the operating troubles which may develop in the M37 series vehicles. Each malfunction for an individual component, unit or system is followed by a list of tests or inspections which will help you to determine probable causes and corrective actions for you to take. You should perform the tests, inspections and corrective actions in order listed in the Troubleshooting table.

3-9. Procedures.

This manual cannot list all possible malfunctions that may occur, or all tests or inspections and corrective actions. If a malfunction is not listed (except when malfunction and cause are obvious), or is not corrected by listed corrective actions, notify your supervisor.

Note. Before you use this table, be sure you have performed all applicable operating checks.



TROUBLESHOOTING

Malfunction

Test or Inspection

Corrective Action

ENGINE

1. Engine Fails to Crank When Starter Pedal is Depressed

Step 1. Inspect for loose, corroded, or broken battery cables.

Clean corroded cables. Tighten loose connections at battery, ground, and starter. If cables are broken, notify organizational maintenance.

2. Engine Cranks, but Will Not Start.

Step 1. Ignition switch in OFF position.

Turn switch to ON position.

Step 2. Check for empty fuel tank.

Fill fuel tank. If engine has been run until fuel is exhausted, operate fuel pump priming lever 30 or 40 strokes to fill fuel line and carburetor float chamber without unnecessary use of starter and drain on batteries.

NOTE. If the priming lever moves freely without operating the diaphragm, crank the engine one revolution to move the fuel pump rocker arm from the high point of the cam on the camshaft.

TROUBLESHOOTING - Continued

Malfunction

Test or Inspection

Corrective Action

ENGINE - Continued

2. Engine Cranks, but Will Not Start (Cont'd).

Step 3. Fuel line shut-off cock closed.

Open fuel line shut-off cock.

Step 4. Combustion chambers flooded with fuel.

Push choke all the way in, open throttle, crank engine to expel excessive fuel.

Step 5. Carburetor air cleaner oil level too high.

Service air cleaner.

Step 6. Fuel filter plugged.

Clean or replace fuel filter element, as required.

3. Engine Starts but Does Not Continue to Run.

Step 1. Out of fuel.

Check fuel level and fill if necessary.

Step 2. Carburetor air cleaner restricted.

Service air cleaner.

Step 3. Fuel filter plugged.

Clean or replace fuel filter element, as required.

TROUBLESHOOTING - Continued

Malfunction

Test or Inspection

Corrective Action

ENGINE - Continued

4. Engine Overheating.

Step 1. Coolant level low.

Check coolant level in radiator and fill to slightly below bottom of filler neck, adding antifreeze solution as necessary.

Step 2. Radiator or hoses leaking.

Look for hose and radiator leaks.

WARNING: If it is necessary to add coolant to the radiator while engine is overheated, idle engine and add coolant slowly. Use extreme care in removing pressure cap, as serious burns may result.

Step 3. Pressure cap missing or not sealing.

Obtain serviceable cap.

Step 4. Radiator obstructed with brush or leaves.

Clean radiator fins and tubes.

Step 5. Fan belt loose or broken.

Adjust or replace fan belt, as required.

5. Lack of Power.

Step 1. Choke not fully open.

Push choke control all the way in.

TROUBLESHOOTING - Continued

Malfunction

Test or Inspection

Corrective Action

ENGINE - Continued

5. Lack of Power (Cont'd).

Step 2. Parking brake applied.

Release parking brake.

Step 3. Carburetor air cleaner restricted.

Service air cleaner.

Step 4. Exhaust system restricted.

Remove obstruction from tailpipe.

Step 5. Fuel filter plugged.

Clean or replace fuel filter element, as required:

6. Excessive Oil Consumption.

Step 1. Crankcase overfilled.

Maintain oil at correct level.

Step 2. External leaks.

Exceeds 3 drops in 5 minute period. Notify organizational maintenance.

7. Spark Knock or Ping. (A sharp metallic knock occurring on acceleration or when operating under heavy load.)

Step 1. Engine overheating.

Refer to Item 4 above.

Step 2. Low octane fuel.

Use correct grade of fuel.

TROUBLESHOOTING - Continued

Malfunction

Test or Inspection

Correction Action

ENGINE - Continued

8. Excessive Fuel Consumption.

Step 1. Leaks.

Inspect fuel system for leaks.

Step 2. Choke not fully open.

Push choke control in.

Step 3. Carburetor air cleaner restricted.

Service air cleaner.

Step 4. Exhaust system restricted.

Remove obstruction from tailpipe.

Step 5. Improper driving techniques.

(Refer to pages 2-77 thru 2-94).

9. Fuel Gage Inoperative or Operating Abnormally.

Fuel tank empty.

Fill fuel tank and observe gage.

10. Oil Pressure Gage Inoperative or Operating Abnormally.

Engine oil supply low.

Fill crankcase to proper level with grade of oil specified in lubrication order LO 9-2320-217-12.

TROUBLESHOOTING - Continued

Malfunction

Test or Inspection

Corrective Action

POWER TRAIN AND STEERING

11. Hard Shifting of Transmission and Front Wheel Drive Transfer.

Incorrect lubrication (too thick for temperature).

Drain and refill with grade of lubricant specified in lubrication order LO 9-2320-212-12.

12. Transmission or Transfer Noisy in Operation.

Step 1. Insufficient lubricant.

Fill to level of filler plug. Refer to lubrication order LO 9-2320-212-12.

Step 2. *Incorrect grade of lubricant.*

Drain and refill with grade of lubricant specified in lubrication order LO 9-2320-212-12.

13. Lubrication Leaks from Gear Cases.

Step 1. Loose drain plug.

Tighten drain plug. Leaks should not exceed 3 drops in 5 minute period.

Step 2. Lubricant level too high.

Drain lubricant to plug level. Refer to lubrication order LO 9-2320-212-12.

14. Abnormal Tire Wear.

Step 1. Tire pressure low.

Inflate to correct pressure.

TROUBLESHOOTING - Continued

Malfunction

Test or Inspection

Corrective Action

POWER TRAIN AND STEERING - Continued

Step 2. Use of front wheel drive on hard surfaced roads at speeds above 25 mph.

Use front-drive only when maximum traction is needed at speeds below 25 mph.

Step 3. Poor driving practice.

Refer to TM 21-305.

15. Wheel Wobbles.

Loose wheel nuts.

Tighten wheel nuts as required.

16. Hard Steering.

Step 1. Tire pressure low.

Inflate tires to proper pressure.

Step 2. Insufficient lubrication of steering linkage.

Lubricate steering gear and linkage in accordance with lubrication order LO 9-2320-212-12.

17. Looseness in Steering.

Tire pressure low.

Inflate to correct pressure.

TROUBLESHOOTING - Continued

Malfunction

Test or Inspection

Corrective Action

HORN AND PANEL LIGHTS

18. Horn Operates Continuously.

Pull connectors apart at horn, underside of hood, rear of engine compartment.

19. Instrument Panel Lights Inoperative.

Light switch in incorrect selector position.

Place light switch "Auxiliary Lever" in proper position.

ACCESSORIES

20. Winch Fails to Operate.

Step 1. Clutch shifter handle disengaged.

Engage handle.

Step 2. Clutch shifter handle engaged.

Drive shaft shearpin broken. (Refer to page 2-84).

21. Winch Will Not Hold Load, When in Neutral.

Winch safety brake faulty.

Notify organizational maintenance.

Section IV - MAINTENANCE PROCEDURES

3-10. General.

This section contains instructions covering maintenance procedures and functions which the crew/operator can perform.

3-11. Wheel and Tire Replacement.

- a. Set parking brake, block wheel opposite the wheel to be removed, for safety precautions.
- b. Loosen wheel nuts. Do not remove.

Note. Nuts for both left wheels have left hand threads.



- c. Remove spare wheel and tire from the stowed position.
- d. Raise wheel off ground, remove wheel nuts and wheel and tire assembly. Use care in lifting wheel off and on studs to avoid damage to threads.
- e. Position spare wheel and tire assembly and tighten retaining nuts finger tight.
- f. Lower wheel to ground, tighten wheel nuts securely. Stow defective tire, jack and wrench.

3-12. Draining and Filling Cooling System.

a. Draining.

CAUTION: Remove radiator cap slowly to relieve pressure.

- (1) Place container under radiator drain cock, and open drain cock.

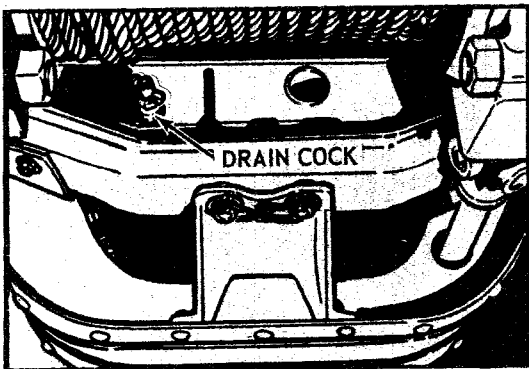

(2) Place container under cylinder block drain cock, and open drain cock. Draining radiator alone will not completely empty cooling system.

Note. Take care to keep drain cocks from clogging while draining. If necessary, use a piece of wire to keep them clear.

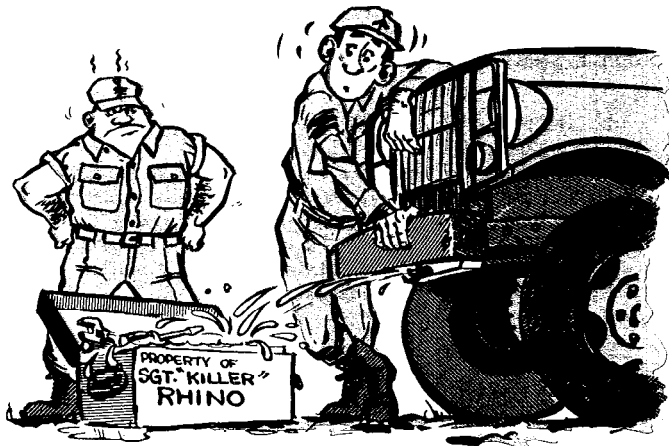

b. Filling.

(1) Close both drain cocks.

(2) Pour coolant into radiator, to a level $2\frac{1}{4}$ -inches below the filler neck top.

Note. If coolant drained is not reused, fill with clean water and rust inhibitor or the prescribed anti-freeze solution.

(3) Start engine and add coolant as required.

CAUTION: Do not fill cooling system when the engine is overheated. Make certain temperature of coolant has dropped considerably below 200°F. before draining and refilling with cold water, to avoid cracking the block and head.

3-13. Checking Electrolyte Level in Batteries.

a. Remove right hand front passenger seat. (Early model ambulance, M43, batteries are under left seat in patient's compartment.)

b. Unscrew and remove the six filler caps on each battery inspecting the electrolyte level. Correct level should be $\frac{3}{8}$ of an inch below the top of the cell, or well above the tops of the plates. If the electrolyte level is low, notify organizational maintenance personnel so that the proper fluid can be replaced, or fill with clean drinking water or rain water. The use of water with high mineral content must be avoided, as it causes rapid deterioration of plates and separators.



c. Corrosion around the battery and terminals causes battery drain and must be avoided. Clean battery and terminals and apply a light coating of petroleum jelly or light grade grease to terminals to prevent corrosion accumulation.

WARNING: In all parts of this operation, use extreme care to prevent battery compartment cover or tools from touching any electrical connection point and any metal part of the vehicle at the same time. Exercise special care when working near the batteries. Each battery is rated at 12 volts and can cause painful injuries when short circuited.

WARNING: Battery acid is dangerous to both skin and clothing. Wash immediately.

3-14. Checking and Filling Carburetor Air Cleaner.

a. The air cleaner shroud provided on vehicles of early manufacturers was discontinued on later vehicles. Maintenance of both types of air cleaner is described.

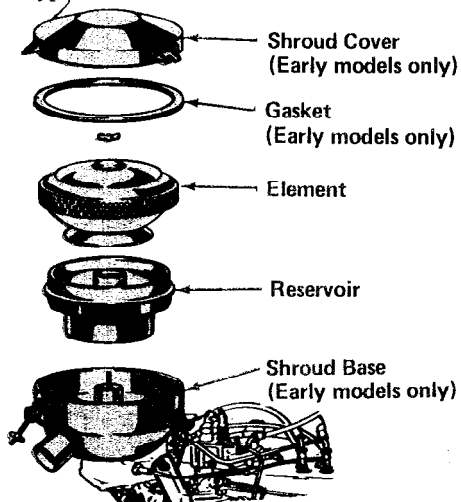

b. Daily, replenish to bead level with OE grade specified in Lubrication Instructions. Every 1000 miles, clean oil reservoir and refill. Disassemble, clean all parts, and refill whenever crankcase oil is changed. For desert or extremely dusty operation, disassemble, clean all parts, and refill once every operating day, or more frequently if required.

(1) On air cleaners equipped with a shroud, loosen wing nuts attaching shroud cover to shroud base. Disengage eyebolts and remove shroud cover with gasket.

(2) Loosen wing nut on top of air cleaner element and remove reservoir and element.

(3) Lift element from reservoir.

(4) If required, remove oil from reservoir and clean element and reservoir (para 3-5). Clean weekly in dusty areas.

(5) Install reservoir on air cleaner retainer.

(6) Fill reservoir to oil level mark with specified lubricant.

(7) Install element in reservoir and tighten wing nut on top of element.

(8) On vehicles so equipped, install cover gasket and position cover on shroud base, alining cover with eyebolts attached to base, and tighten wing nuts.

3-15. Checking Engine Oil Level.

a. General. The oil level dipstick indicates oil level in the engine crankcase. Two marks, FULL and ADD OIL, are scribed on the gage. The space between the marks represents one quart of oil.

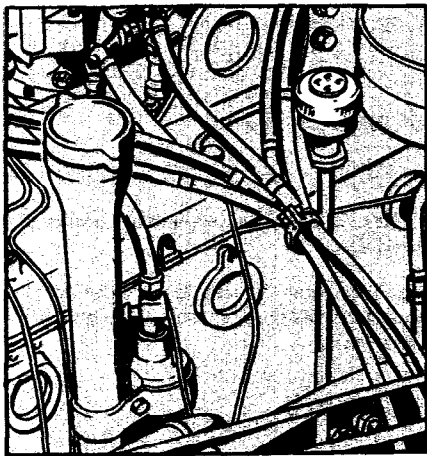

b. Checking Oil Level. Turn gage cap counterclockwise to unlock cap and pull gage from gage pipe. Wipe oil from gage, insert it in pipe and engage cap so that an accurate reading will be obtained. Remove gage and note oil level.

CAUTION: The vehicle must be standing on level ground to obtain a true reading. If engine has been in operation, sufficient time must be allowed for oil in the engine to drain back into crankcase.

c. Maintaining Oil Level. If the true oil level is between the FULL and ADD OIL marks, the level is in the "safe operating range" and the vehicle can be safely operated. However, when experience with a particular vehicle indicates that the oil level will drop below the ADD OIL mark before the next scheduled oil level check, sufficient oil, OE grade as specified in Lubrication Instructions, should be added to the crankcase to bring the oil level to the FULL mark on the dipstick. Install gage and turn cap clockwise to secure it in the oil level gage pipe.

3-16. Checking and Filling Gear Cases.

a. Winch (Page 3-37).

(1) Every week, check level of worm housing and clutch housing, (1) and (2).

(2) Remove filler plug (1) and (2) and fill to plug level before operation with GO grade specified in Lubrication Instructions. Do not overfill.

b. Transmission (Page 3-37).

(1) Check level weekly.

(2) To check level, remove fill and level plug (3) located at upper rear side of right hand power-take-off cover.

(3) Remove filler plug (3) and fill to level of screw hole (4) with GO grade specified in Lubrication Instructions.

(4) When replacing capscrew (4), discard lock washer and replace with copper or brass flat washer.

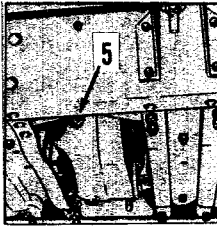
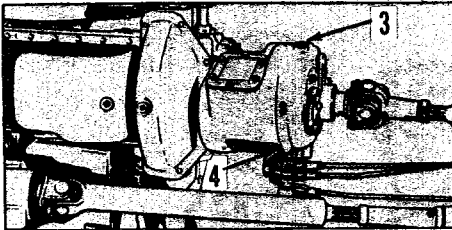
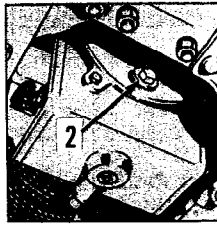
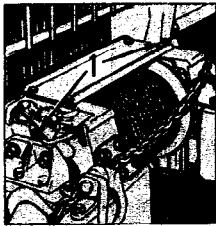

KEY:

1. Winch worm housing and clutch housing filler plug
2. Winch worm housing and clutch housing level plug
3. Transmission fill and level plug.
4. Transmission level screw
5. Transfer filler and level plug
6. Differential filler and level plug
7. Differential air vent

c. Transfer and Differentials (Key 5, 6 and 7).

(1) Check level weekly.

(2) Fill to plug levels (5, and 6) before operation with GO grade specified in Lubrication Instructions.

(3) Clean air vents (7) weekly, and after operation in mud and water. Vents must operate properly to prevent failure of oil seals and contamination of lubricants.



IN OTHER WORDS...
KEEP YOUR VEHICLE
FROM GETTING INTO
ANY 'NICE MESS'!

A-1. Vehicle Publications.

The following publications contain information pertinent to major item material and associated equipment.

a. Vehicle.

Organizational Maintenance: Cargo Truck, 3/4-Ton, 4 x 4, M37 and M37B1; Ambulance Truck, 3/4-Ton, 4 x 4, M43 and M43B1; and Maintenance Truck, 3/4-Ton, 4 x 4, M201 and M201B1. TM 9-2320-212-20

Organizational Maintenance Repair Parts and Special Tools List: Cargo Truck, 3/4-Ton, 4 x 4, M37 and M37B1; Ambulance Truck, 3/4-Ton, 4 x 4, M43 and M43B1; and Maintenance Truck, 3/4-Ton, 4 x 4, M201 and M201B1. TM 9-2320-212-20P

Lubrication Order: Cargo Truck, 3/4-Ton, 4 x 4, M37 and M37B1; Ambulance Truck, 3/4-Ton, 4 x 4, M43 and M43B1; and Maintenance Truck, 3/4-Ton, 4 x 4, M201 and M201B1. LO 9-2320-212-12

b. General Publication.

Driver's Manual TM 21-305
Operation and Maintenance of Ordnance
Material in Extreme Cold Weather
(0° to -65°F) TM 9-207
Deepwater Forging of Ordnance Material TM 9-238

b. General Publications (Cont'd.)

The Army Maintenance Management System (TAMMS)	TM 38-750
Expendable Items (except medical, Class V, repair parts and heraldic items)	SB 700-50
Operator, Organizational and Field (Third Echelon) Maintenance Repair Parts and Special Tool List and Maintenance Allocation Chart, Axles RL-27-B, RL-27-C, and RL-27-D	TM 11-3895-201-13P



**APPENDIX B
BASIC ISSUE ITEMS LIST (BIIL) AND
ITEMS TROOP INSTALLED
OR AUTHORIZED LIST (ITIAL)**

Section 1. INTRODUCTION

B-1. Scope.

This appendix provides a list of Basic Issue and Items Troop Installed or Authorized. These items are required to operate the equipment and enable it to perform its mission and function for which it was designed or intended.

B-2. General.

This appendix is divided into the following sections:

a. Section II - Basic Issue Items List. A list of essential items which are furnished with the vehicle and not otherwise provided for in appropriate TDA. (None allocated).

b. Section III - Items Troop Installed or Authorized List. This is equipment not provided in TOE, TDA or Expendable Items. The common tools and equipment can be obtained from authorized supply sources at the discretion of the unit commander.

B-3. Explanation of Columns.

The following provides an explanation of columns found in the tabulator listings of Section II and Section III.

a. Source, Maintenance, and Recoverability Codes (SMR).

(1) Source Code indicates the selection status and source for the listed item. Source Codes are:

Code	Explanation
P	Repair parts which are stocked in or supplied from the GSA/DSA, or Army Supply System and authorized for use at indicated maintenance categories.

(2) Maintenance Code indicates the lowest category of maintenance authorized to install the listed item. The maintenance level code is:

Code	Explanation
C	Crew/Operator

(3) Recoverability Code indicates whether unserviceable items should be returned for recovery or salvage. Items not coded are expendable. Recoverability Codes are:

Code	Explanation
R	Repair parts and assemblies which are economically repairable at GS activities and are normally furnished by supply on an exchange basis.
S	Repair parts and assemblies which are economically repairable at DS and GS activities and which normally are furnished by supply on an exchange basis. When items are determined by GSU to be uneconomically repairable, they will be evacuated to a depot for evaluation and analysis before final disposition.
T	High dollar value recoverable repair parts which are subject to special handling and are issued on an exchange basis. Such repair parts normally are required or overhauled at depot maintenance activities. Repair parts specifically selected for salvage by

reclamation units because of precious metal content, critical materials, or high dollar value, or reusable castings or casings.

- U Repair parts specifically selected for salvage by reclamation units because of precious metal content, critical materials, or high dollar value, or reusable castings or casings.

b. Federal Stock Number. This column indicates the Federal Stock Number assigned to the item and will be used for requisitioning purposes.

c. Description. This column indicates the Federal item name and any additional description of the item required. A part number or other reference number is followed by the applicable five-digit Federal supply code for manufacturers in parentheses. Repair parts quantities included in kits, sets, and assemblies are shown in front of the repair part name. Usable On Code identifies the vehicle model an item is used on. Uncoded items are applicable to all models.

d. Unit of Measure. A two-character alphabetic abbreviation indicating the amount or quantity of the item upon which the allowances are based, e.g., ft, ea, pr, etc.

e. Quantity Furnished With Equipment. This column indicates the quantity of an item furnished with the equipment.

f. Illustration. This column is divided as follows:

(1) Figure number. Indicates the figure number of the illustration in which the item is shown.

(2) Item number. Indicates the callout number used to reference the item in the illustration.

g. Quantity Authorized. Indicates the quantity of the item authorized to be used with the equipment.

B-4. Special Information.

The following publications and prescribed forms are packed with the equipment:

- 7510-889-3494 Binder: Equip Log Book, Loose Leaf, 3-Ring 7- $\frac{3}{4}$ " x 10- $\frac{1}{4}$ " (In pamphlet bag) MIL-B-43064 (81349).
- DA Form 2408 Equipment Log Assembly (Records) (In Equipment Log Book Binder).
- LO 9-2320-212-12 Lubrication Order for truck, cargo, $\frac{3}{4}$ -ton, 4 x 4, M37, M37B1, truck, ambulance, $\frac{3}{4}$ -ton, 4 x 4, M43, M43B1 and truck, maintenance, $\frac{3}{4}$ -ton, 4 x 4, M201 and M201B1 (In pamphlet bag).
- TM 9-2320-212-ESC Equipment Serviceability Criteria for truck, cargo, $\frac{3}{4}$ -ton, 4 x 4, M37, M37B1, truck ambulance. $\frac{3}{4}$ -ton, 4 x 4, M43, M43B1 and truck, maintenance, $\frac{3}{4}$ -ton, 4 x 4, M201 and M201B1 (In pamphlet bag).
- TM 9-2320-212-10 Operator's manual for truck, cargo: $\frac{3}{4}$ -ton, 4 x 4, M37, M37B1, truck, ambulance, $\frac{3}{4}$ -ton, 4 x 4, M43, M43B1 and truck, maintenance, $\frac{3}{4}$ ton, 4 x 4, M201, M201B1 (in pamphlet bag).

B-5. Abbreviations and Symbols.

a. Symbols.

Symbol

Explanation

Listed for identification of items in -20P.

b. Abbreviations.

Abbreviation	Explanation
adj	adjustable
cap	capacity
cc	cubic centimeter(s)
comb.	combination
dbl-hd	double head
elect.	electric(al)
extn	extension
ft	foot(feet)
gal.	gallon(s)
glvd-fin.	galvanized finish
hdl	handle
hex	hexagon(al)
in.	inch(es)
lb	pound(s)
lg	long
lubr	lubrication
mach	machine
nom	nominal
oz	ounce(s)
psi	pounds per square inch
pt	pint(s), point
qt	quart(s)
rd	round
rd-pt	round point
sq drive	square drive
w/	with
w/o	without
yd	yard

Section II. BASIC ISSUE ITEMS LIST

(1) SMR Code	(2) Federal Stock Number	(3) Description Reference Number & Mfg Code Usable On Code	(4) Unit of Meas.	(5) Qty Auth.
		NONE AUTHORIZED		

Section III. ITEMS TROOP INSTALLED OR AUTHORIZED LIST

(1) SMR CODE	(2) FEDERAL STOCK NUMBER	(3) DESCRIPTION Reference No. & Mfg Code Usable On Code	(4) UNIT OF MEAS.	(5) QTY. AUTH.
PC	5110-293-2336	AXE, SINGLE BIT: 36 in. w/handle, 4 lb (M37, M37B1) (in bracket on tailgate) (41-A-1277)	ea	1
PC	2540-054-0022	CHAIN, PNEUMATIC TIRE: truck, single 9.00 x 16, Type TS (in Tool Compartment, R or L front side of body exterior) (96906-MS-51381-22)	ea	1
PC	51120-243-2419	BAR, SOCKET WRENCH HANDLE: 3/4- diameter, 30 inch long. Type A used w/ wrench 41-W-3843 (41-H-1541-10) (in tool compartment R or L side of body exterior)	ea	1
PC	3940-609-8026	BLOCK, SNATCH: wire rope, 5-ton, working load, single 6-½ inch sheave, w/swivel hook, ½ inch diameter rope (M201, M201B1) in tool compartment, R or L front side of body exterior) 8383240	ea	1

Section III. ITEMS TROOP INSTALLED OR AUTHORIZED LIST - Continued

(1) SMR CODE	(2) FEDERAL STOCK NUMBER	(3) DESCRIPTION Reference No. & Mfg Code Usable On Code	(4) UNIT OF MEAS.	(5) QTY. AUTH.
PC	2540-670-2459	BAG, PAMPHLET: cotton duck, 3 x 9- $\frac{1}{4}$ x 11- $\frac{1}{4}$ (in tool compartment under driver's seat)	ea	1
PC		CASK, WATER: thermos, spigot type, 3-gallon cap, stainless steel lined w/carrying handles (M201, M201B1) (on top of body left front side) 10947122-1	ea	1
PC	5120-357-6106	HANDLE: jack, tubular 27/32 inch diameter, 20 inch long (in tool compartment R or L front side of body exterior) (41-H-1251-300)	ea	1
PC	5120-254-6618	HANDLE, MATTOCK PICK: 36 inch long (M37, M37B1) (in bracket on tailgate)	ea	1
PC	5120-233-6829	JACK, HYDRAULIC, HAND: self-contained, 3-ton, 9- $\frac{1}{4}$ inch closed, 16-7/8 inch extended, w/operating instructions (decal in tool compartment, R or L front side of body exterior) (96906-MS-16283-1)	ea	1

PC	5120-243-2395	MATTOCK, PICK: w/o handle, 5-lb (M37, M37B1) (in bracket on tailgate)	ea	1
PC	5120-223-7397	PLIERS, SLIPJOINT: sight nose, comb, w/ cutter, 8 inch long (41-P-1652) (in tool bag)	ea	1
PC	5120-234-8912	SCREWDRIVER: cross tip, phillips type, plastic handle No. 3 size, 6 inch (in tool bag) (96906-MS-15224-6)	ea	1
PC	5120-222-8852	SCREWDRIVER: flat tip, plastic handle, ¼-inch flared tip, 4 inch long (in tool bag) (96906-MS-15219-9)	ea	1
PC	5120-293-2452	WRENCH: double head socket, hex, 1-1/16 inch opening, 10 inch long (41-W-3843-15) (in tool compartment, R or L front side of body exterior)	ea	1
PC	5120-708-3302	WRENCH: drain plug, straight bar, ½ inch square plug 2-½ inch long (41-W-1692-10) (in tool bag)	ea	1
PC	5120-240-5328	WRENCH: open end, adj, single head, 15/16 inch jaw opening 8 inches long (in tool bag) (96906-MS-15461-3)	ea	1

TA 008694

B-7